

Dell™ Network Management Card

User's Guide

Notes and Warnings



NOTE: A NOTE indicates important information that helps you make better use of your software.



DANGER: A DANGER indicates an imminently hazardous situation which, if not avoided, will result in death or serious injury.



WARNING: A WARNING indicates a potentially hazardous situation which, if not avoided, could result in death or injury.



CAUTION: A CAUTION indicates a potentially hazardous situation which, if not avoided, may result in minor or moderate injury or in property damage incidents.

Information in this document is subject to change without notice.

© 2009 Dell Inc. All rights reserved.

Reproduction in any manner whatsoever without the written permission of Dell Inc. is strictly forbidden.

Trademarks used in this text: *Dell* and the *DELL* logo are trademarks of Dell, Inc. *HyperTerminal* is a registered trademark of Hilgraeve. *Internet Explorer*, *Microsoft*, and *Windows* are registered trademarks of Microsoft Corporation. *Mozilla* and *Firefox* are registered trademarks of the Mozilla Foundation. *Phillips* is a registered trademark of Phillips Screw Company.

Other trademarks and trade names may be used in this document to refer to either the entities claiming the marks and names or their products. Dell Inc. disclaims any proprietary interest in trademarks and trade names other than its own.

Table of Contents

1	Introduction	
2	Getting Started	
	Unpacking the Card	8
	Installation Checklist	9
	Card Details	10
	Card Defaults	11
	Installing the Card	12
	Connecting the Card	12
	Configuring the Card	14
	Configuring the Network With a DHCP Server	16
	Configuring the Network Without a DHCP Server	17
	Testing the Configuration	18
3	Configuring the Card	
	Navigating the Card's Web Page	20
	Logging In	21
	Optimizing Browser Performance	21
	Online Help	22
	UPS Properties	23
	UPS Measurements Detail	24
	UPS Status Icons	24
	UPS Status List	29
	UPS Status	30
	View Current Alarms	31
	View Power Consumption	35
	View UPS and Card Information	36

UPS Control	37
UPS Weekly Schedule Programming	39
Shutdown Parameters	40
UPS Shutdown (Inverter)	41
Load Segments Shutdown	41
Measurements	42
Event Log	43
System Log	44
Notification	45
E-Mail Notification	45
E-Mail Message Settings	47
Sending Text Messages	48
Network Settings	49
System Settings	52
Notified Applications	53
Access Control	55
Date and Time	57
4 MIB Objects	
IETF UPS MIB	59
Dell UPS MIB	64
Product Identification Group	64
Product Status Group	65
Product Physical Group	66
Traps	69

5 Specifications

6 Operation and Maintenance

Serial Cable Pinout	79
Serial Configuration Menus	79
Option 1: Reset	80
Option 2: Network Configuration	81
Option 3: Set Login Password to Default	83
Option 4: Return to Default Configuration	84
Upgrading the Card's Firmware	85

7 Shutdown Criteria and Sequence

Shutdown Criteria Managed by the Card	87
Shutdown Sequence	88
Load Segments	88

Introduction

The Dell™ Network Management Card works with Dell UPS Management Software to monitor, manage, and protect uninterruptible power supplies (UPSs) through standard Web pages, Simple Network Management Protocol (SNMP), and Secure Sockets Layer (SSL) security protocol. The Dell Network Management Card can support up to five connected browsers at a time, or three with SSL protocol.

You can configure the card with any one of the following options:

- Web browser
- Local serial link (network parameters)
- Bootstrap Protocol/Dynamic Host Configuration Protocol (BOOTP/DHCP, network parameters)

In addition, the Dell Network Management Card has the following features:

- Simultaneous monitoring of up to five connected browsers (three in SSL)
- Configuration of automatic e-mail message in response to UPS alarms and to transmit periodic reports
- Control of UPS on/off switching with a Web browser
- Adjustment and control of load segments through the Web interface, including sequential starting of the installation and optimization of backup time by shutting down non-priority systems
- Automatic date and time adjustment through an NTP server
- Protection by encrypted password
- Protection by secure SSL connection (enabled by default)
- Recording of events and measurements in the non-volatile memory
- Languages available:
 - English
 - French
 - Spanish
 - German
 - Simplified Chinese
 - Japanese
 - Russian
 - Korean
 - Traditional Chinese

- Online Help (English only)
- Card firmware updated through the network
- UPS firmware updated through the network
- Fast Ethernet 10/100 MB compatibility with auto-negotiation on the RJ-45 port
- Connection to the card with straight CAT 5 RJ-45 network cables [maximum card distance is 20m (65 ft)]
- Easy installation—the Dell Network Management Card can be installed while the UPS is online, maintaining the highest system availability
- Compatibility with the Internet Engineering Task Force (IETF) Management Information Base (MIB) and the Dell MIB (see Chapter 4, “MIB Objects” on page 59); Limitation: IETF MIB traps are not sent by the card

Getting Started

This chapter explains:

- Unpacking the card
- Checklist items needed for installation
- Identifying the card ports and indicators
- Card defaults
- Installing and connecting the card
- Configuring the network with a DHCP server
- Configuring the network without a DHCP server

Unpacking the Card

Verify the package contents (see Figure 1):

- Dell Network Management Card
- Serial cable
- Setup instructions
- Safety, Environmental, and Regulatory Information

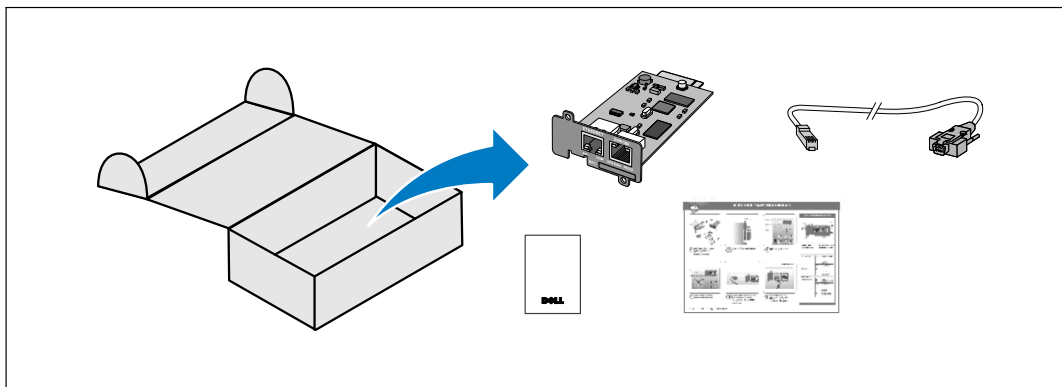

Figure 1. Dell Network Management Card Package Contents

Installation Checklist

- 1 Verify that all of the following items are available:
 - Dell Network Management Card package contents
 - Phillips® screwdriver
 - Ethernet cable
 - Available serial port (RS-232)
 - HyperTerminal® (ships with Microsoft® Windows®) or equivalent terminal emulation application
 - Web browser (Microsoft Internet Explorer® or Mozilla® Firefox® recommended)
- 2 Provide the local network administrator with the card's MAC address:
 - MAC Address Port: _____
 - The MAC address is located on the label on the front of the card (see Figure 2).

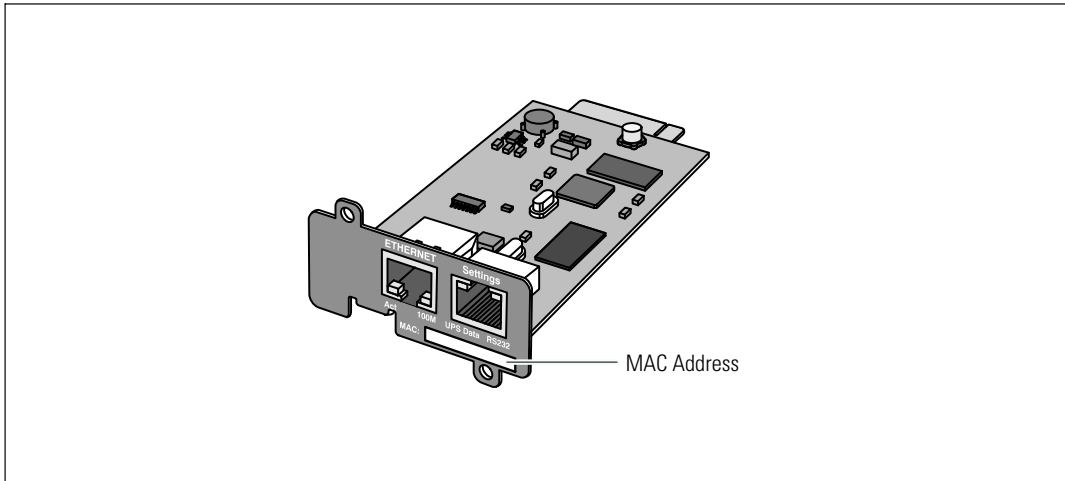

Figure 2. MAC Address Location

Card Details

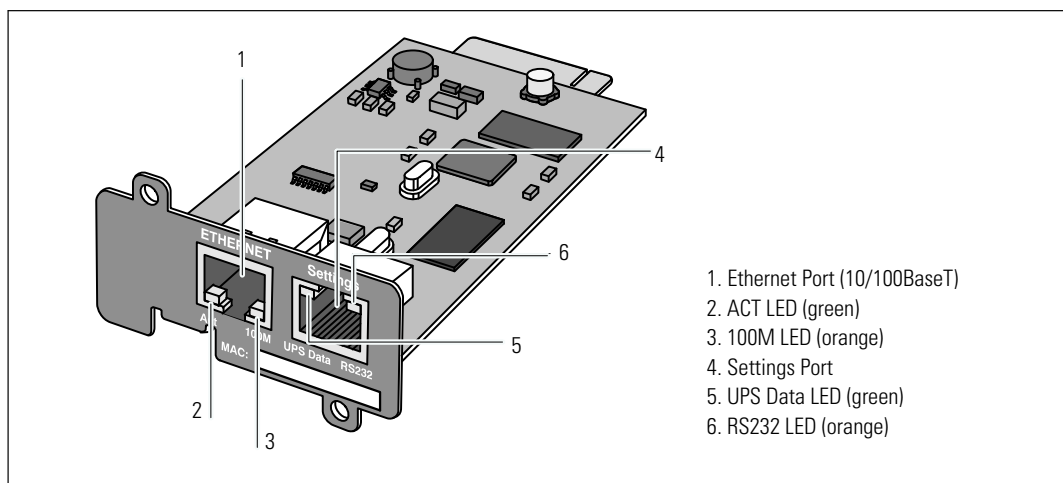

Figure 3. Dell Network Management Card Details

Table 1. Indicator Descriptions

Ethernet Port (10/100BaseT)		
ACT LED (green)	Off	Card is not connected to the network
	On	Card is connected to the network, but no activity
	Flashing	Card is sending/receiving
100M LED (orange)	Off	Port is operating at 10 Mbits/s
	On	Port is operating at 100 Mbits/s
Settings Port		
UPS Data LED (green)	Off	Card is starting
	On	Card is communicating with the UPS
	Flashing	Normal operation; communication with the UPS is operational
RS232 LED (orange)	Off	Normal operation; Configuration menu is not activated
	On	Configuration menu is activated

Card Defaults

Table 2 lists the Dell Network Management Card default parameters.

Table 2. Default Parameters

Function On	Parameter	Default Value	Possible Values
Network	IP Address	192.168.1.2	Network IP address
	Subnet Mask	255.255.0.0	Network IP address
	Gateway Address	0.0.0.0	Network IP address
	BOOTP/DHCP	Enabled	Enabled / Disabled
	Firmware Upload	Enabled	Enabled / Disabled
	SMTP Server	smtpserver	49 characters maximum
	SSL	Enabled	Enabled / Disabled
	SNMP	Disabled	Enabled / Disabled
System	UPS Contact	Computer Room Manager	49 characters maximum
	UPS Contact	Computer Room	31 characters maximum
	History Log Interval	60 seconds	10 to 99999 seconds
	Default Language	English	English / French / Spanish / German / Simplified Chinese / Japanese / Russian / Korean / Traditional Chinese
Access Control	User Name	admin	10 characters maximum
	Password	admin	10 characters maximum
	Community Name Read	Public	49 characters maximum
	Trap Port	162	Non-configurable
Date and Time	Date and Time Adjustment	Synchronize manually	Synchronize with an NTP server / Synchronize manually
	NTP Server	Ntpserver	49 characters maximum
Serial Link	Speed	9600 baud	Non-configurable
	Data Bits	8	Non-configurable
	Stop Bits	1	Non-configurable
	Parity	None	Non-configurable
	Flow Control	None	Non-configurable

Installing the Card

The Dell Network Management Card can be installed in any Dell UPS equipped with a communication bay without turning off the UPS or disconnecting the load.

To install the Dell Network Management Card:

- 1 Remove the communication bay cover from the UPS. Retain the screws.
- 2 If not already done, record the card's MAC address for future reference (see “Installation Checklist” on page 9).
- 3 To prevent electrostatic discharge (ESD), place one hand on a metal surface.
- 4 Slide the card into the open slot and secure with the screws removed in Step 1 (see Figure 4).

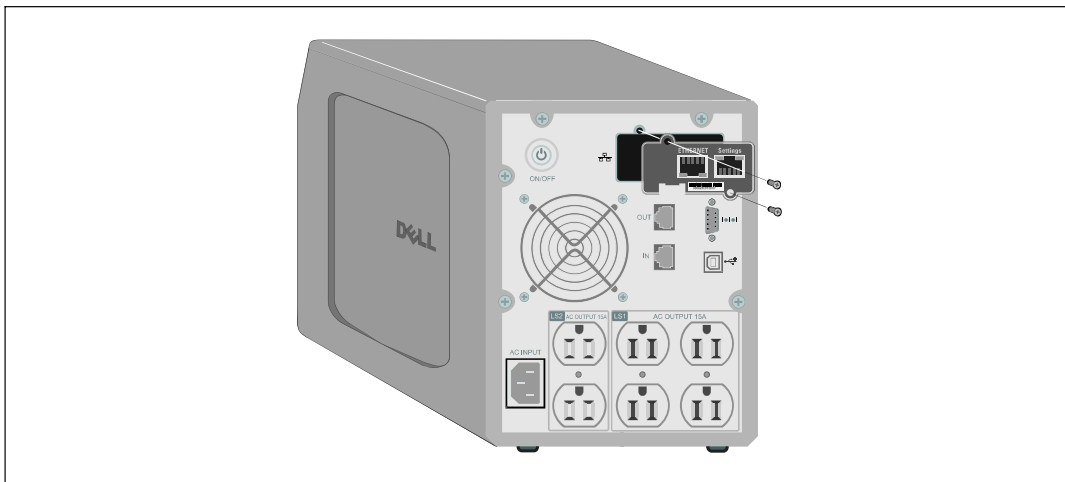



Figure 4. Installing the Card

Connecting the Card

To connect the card to the computer and start the configuration:

- 1 Plug the RJ-45 end of the supplied serial cable into the Settings port on the card (see Figure 5).

 **NOTE:** You can set the card parameters through the Settings port even if the network is not connected. The Ethernet port on the card does not work for configuration.

- 2 Plug the other end of the serial cable into the serial COM port on the computer.

- 3 Connect an active Ethernet cable (not supplied) to the Ethernet port on the Dell Network Management Card (see Figure 5).

Wait approximately two minutes until the UPS Data LED flashes regularly, indicating normal operation.

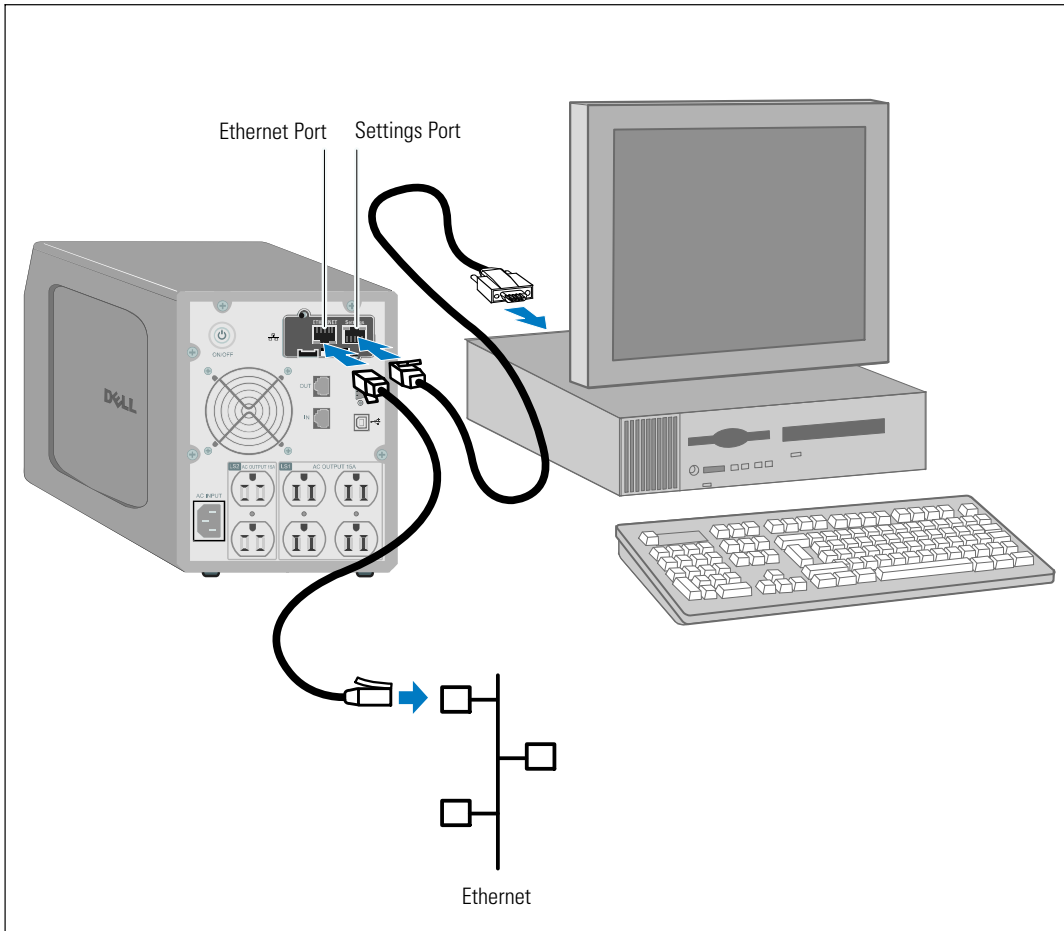

Figure 5. Connecting the Card

Configuring the Card

To configure the card:

- 1 Verify that the serial cable (supplied) is connected to the card's Settings port and the computer's COM port.
- 2 Open your terminal emulation program (such as HyperTerminal).
- 3 Select the serial connection (such as COM1).
- 4 Set the serial line to **9600 baud, 8 data bits, No parity, 1 stop bit, no flow control** (see Figure 6).

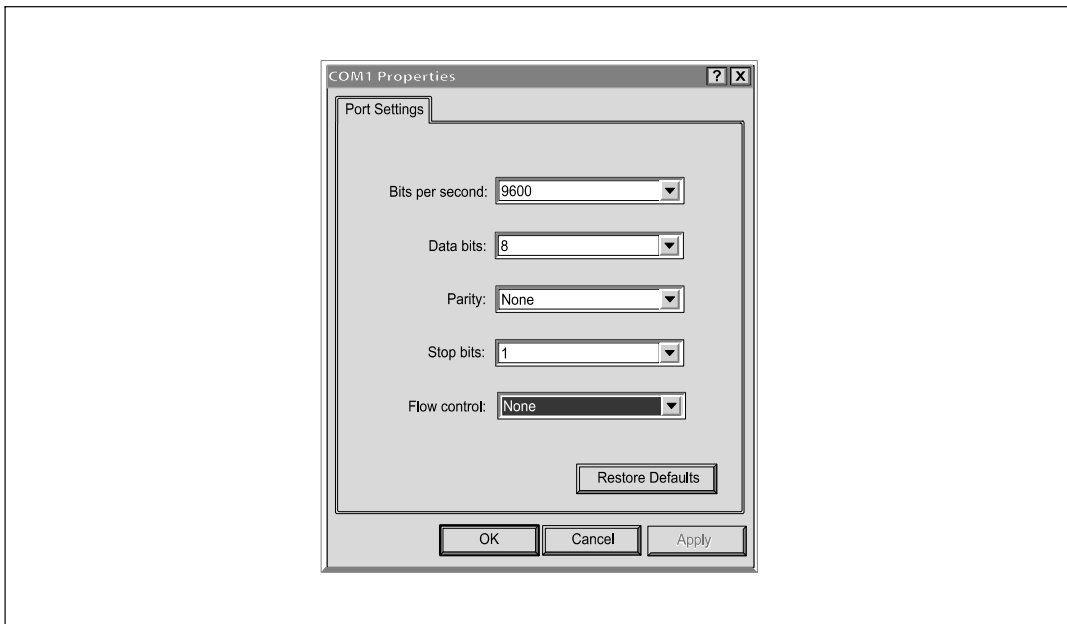

Figure 6. Configuring Port Settings

- 5 Verify that the UPS is turned on.

The initialization process completes, and you are prompted enter the password (Figure 7).

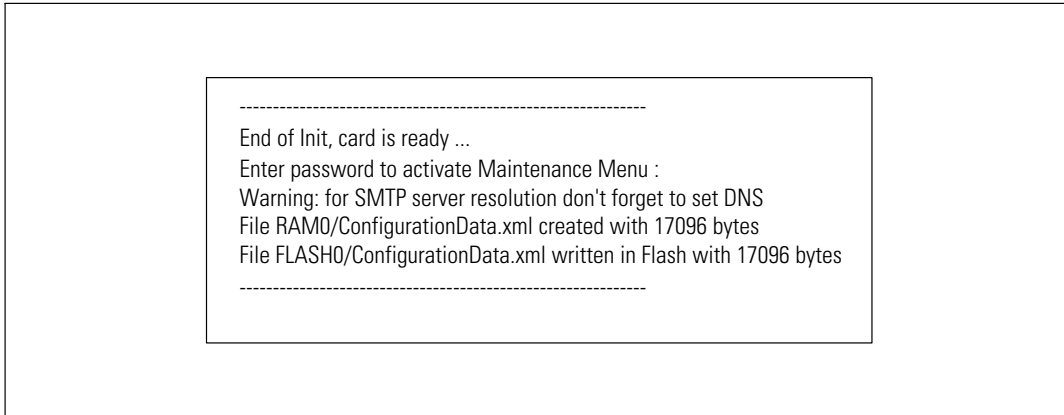

Figure 7. Card Initialization

- 6 Enter `admin`. The main menu displays (see Figure 8).

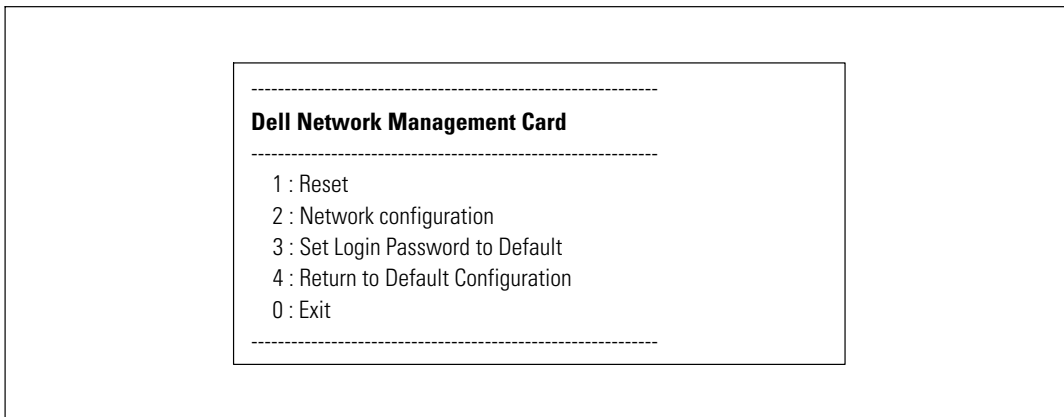



Figure 8. Dell Network Management Card Main Menu

Configuring the Network With a DHCP Server

The card automatically collects the IP parameters from the server by default.

 **NOTE:** When the card is not connected to the network, it continuously attempts to connect. When the connection is established, the LEDs indicate the status (see Table 1 on page 10).

To view the parameters:

- 1 From the main menu, type **2** and press **Enter**. The Network Settings menu displays (see Figure 9).

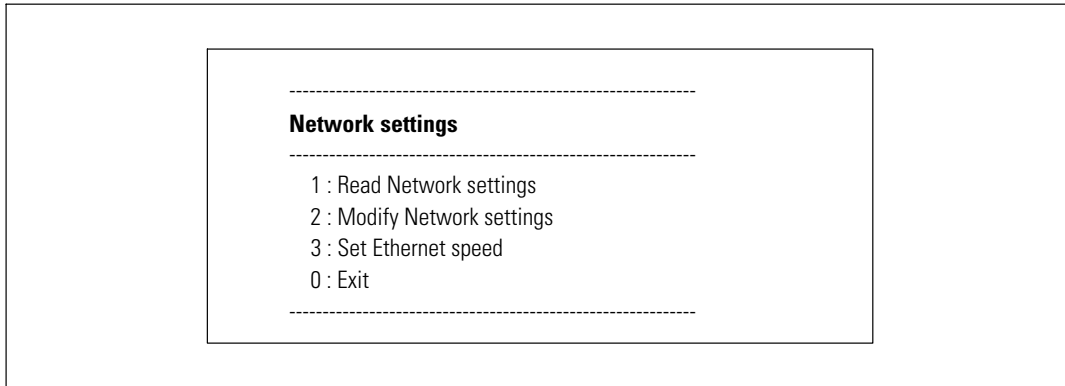

Figure 9. Network Settings Menu

- 2 Type **1** and press **Enter**. The card displays the settings supplied by the server (see Figure 10).

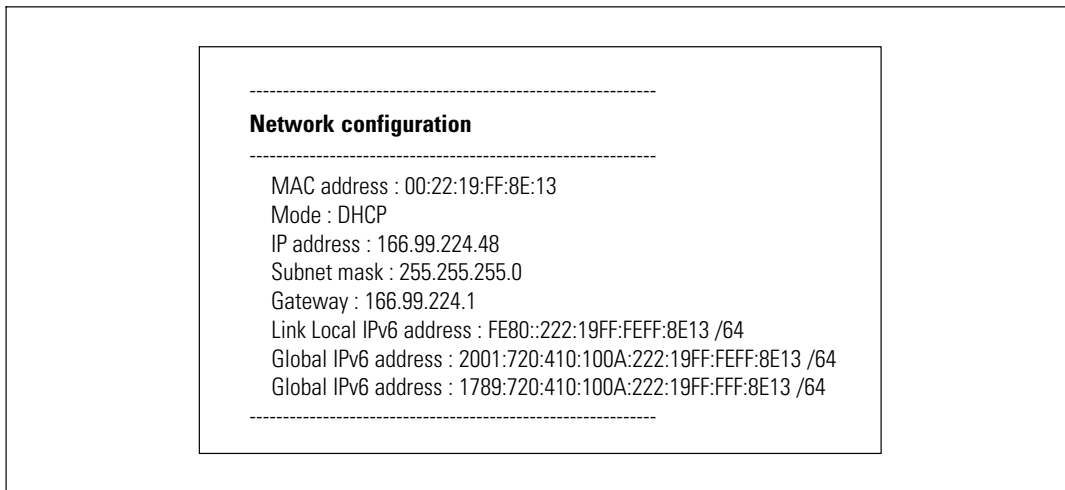



Figure 10. Network Configuration Menu

- 3 Record the IP address.
- 4 To exit, type 0 and press **Enter**; then type 0 and press **Enter** again. The card is now operational.

Configuring the Network Without a DHCP Server

To set the network configuration manually:

- 1 From the main menu, type 2 and press **Enter**. Type 2 and press **Enter** again to modify the network settings. The Network Settings menu displays (see Figure 11).

 **NOTE:** You cannot configure the IPv6 address through the serial link. The IPv6 address is provided by the card or by the IPv6 DHCP server (if an IPv6 DHCP server is available on the network). See “Network Settings” on page 49 to enable the IPv6 feature and configure IPv6 settings.

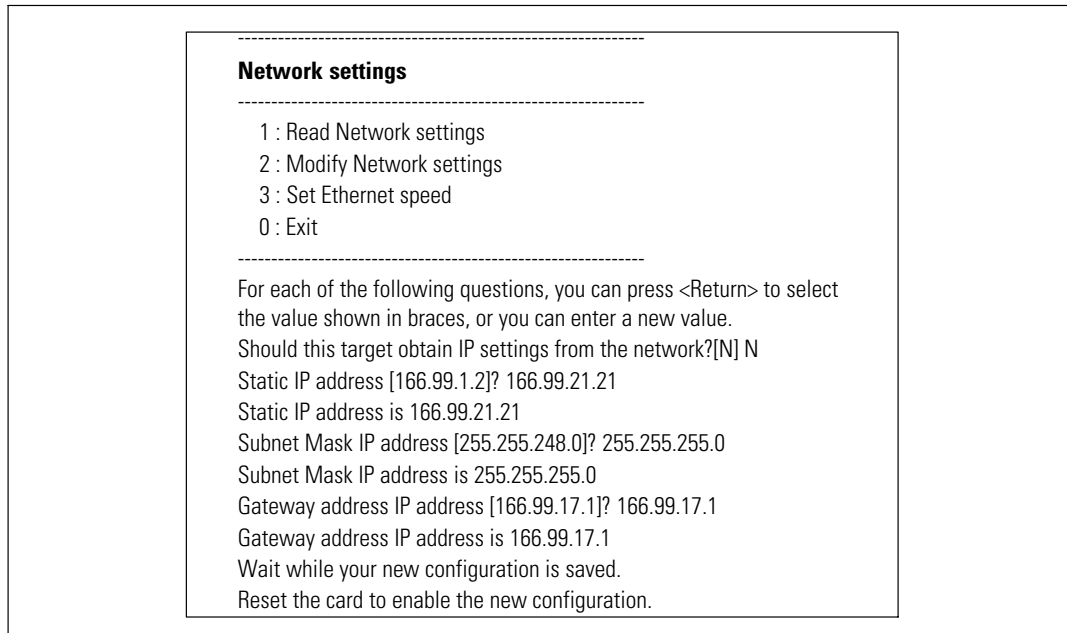

Figure 11. Modifying the Network Settings

- 2 Follow the instructions and enter the static IP parameters (IPv4 only).
Wait until **Done** displays, indicating that the IP parameters have been saved.
- 3 To exit, type 0 and press **Enter**.
- 4 Type 1 and press **Enter**, and then type 2 and press **Enter** to restart.
The card restarts with the new IP settings in approximately one minute.

Testing the Configuration

To verify that the Dell Network Management Card is operational:

- 1 Open a Web browser from a station connected to the same subnet as the card.
- 2 Enter the card's **https://IP address** (IPv4 or IPv6) in the address bar. The home page displays (see Figure 12).

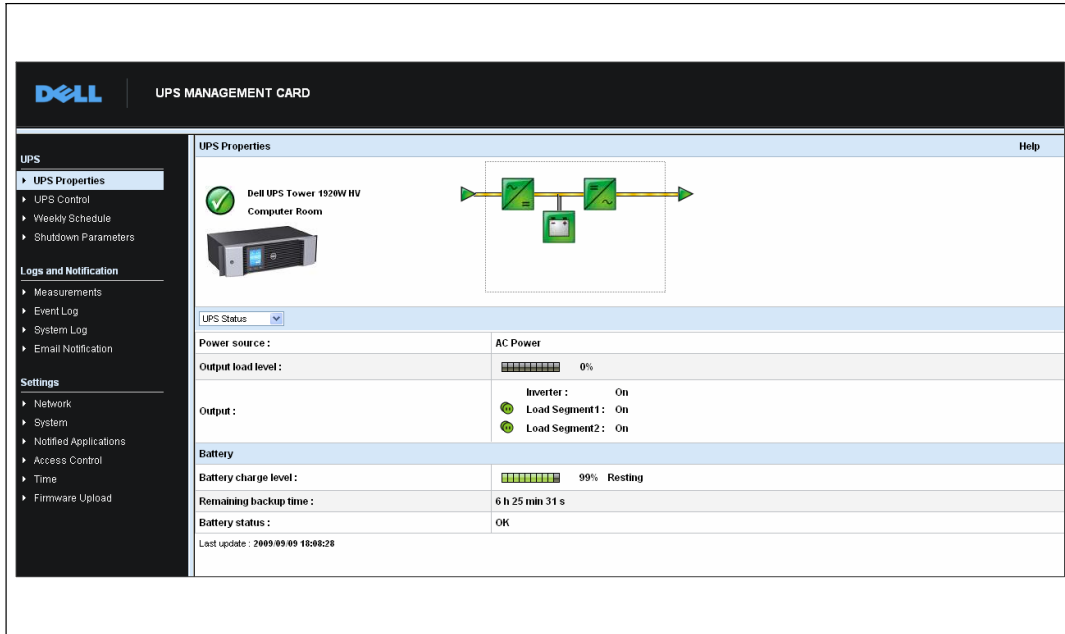



Figure 12. Home Page

If you logged in as admin, continue to Chapter 3, “Configuring the Card,” on page 19 for additional configuration options.

Configuring the Card

 **NOTE:** You must be logged in as admin to configure the card.

This chapter explains:

- Navigating the card's Web page
- Understanding UPS properties
- UPS power management
- Understanding UPS measurements, Event log, and System log
- Configuring e-mail notification
- Configuring Simple Network Management Protocol (SNMP) options and managing from an SNMP NMS
- Setting up access control
- Setting the date and time

Navigating the Card's Web Page

Figure 13 shows the different areas and features of the card's Web page. The UPS Properties page is the home page that displays after you log on to the Web interface.

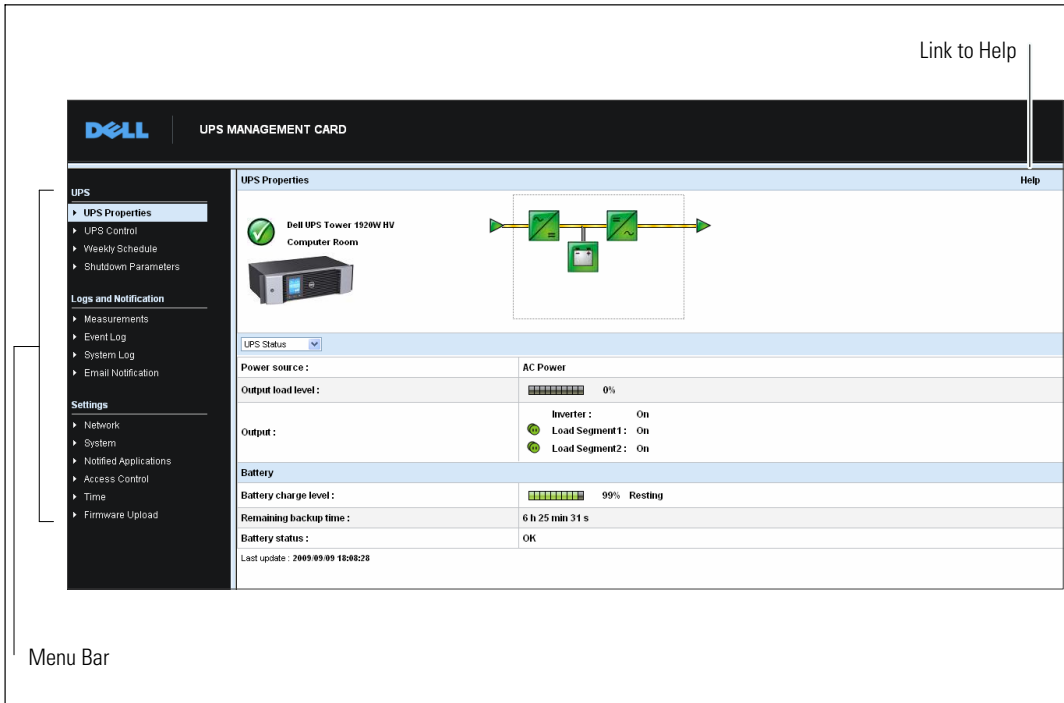

Figure 13. Navigating the Card's Web Page

The menu bar to the left of the page contains links to the card's additional pages for status information and configuration options. Menus are expandable and collapsible.

Logging In

By default, the user name and password are both **admin** (see Figure 14).

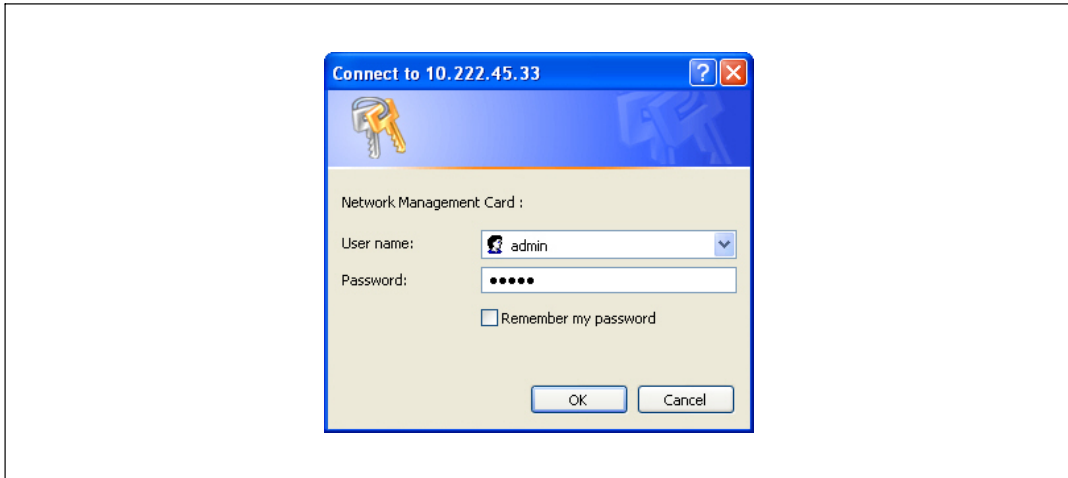

Figure 14. Login Window

Both the user name and password fields accept a maximum of ten characters. After five minutes have elapsed, or if the browser is closed and reopened, you must re-enter the user name and password.

An error in either field results in rejection of the requested action (such as save, page access, or card reboot). After three unsuccessful login attempts, you must restart the browser. Both the user name and password fields are encrypted with an MD5 type algorithm, ensuring total security.

See “Option 3: Set Login Password to Default” on page 83 to reset the password.

Optimizing Browser Performance

To view status changes on the UPS in real time, configure the browser so that it automatically refreshes all the objects on the current page.

For example, if you are using Internet Explorer:

- 1 Go to **Tools > Internet Options > General > Temporary Internet files > Settings**.
- 2 Select **Every visit to the page**.
- 3 Click **OK** to close the Settings window, and then click **OK** again to close the Internet Options window.

Online Help

The Dell Network Management Card's online Help provides information on all main menu items.

 **NOTE:** The Help is in English only.

To access Help:

- 1 Click **Help**. The Help page opens(see Figure 15).
- 2 Select a Help topic from the menu bar. The corresponding Help content displays on the right.

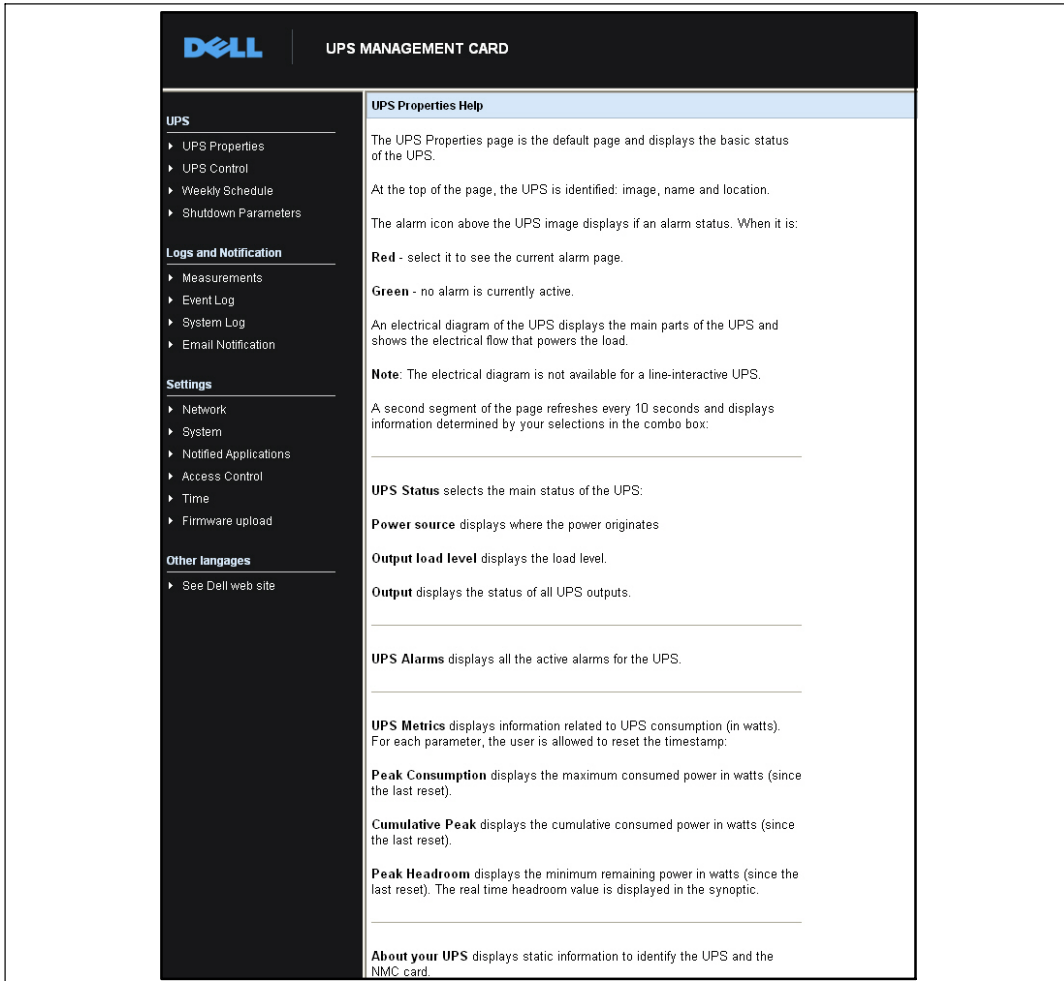

UPS

- ▶ UPS Properties
- ▶ UPS Control
- ▶ Weekly Schedule
- ▶ Shutdown Parameters

Logs and Notification

- ▶ Measurements
- ▶ Event Log
- ▶ System Log
- ▶ Email Notification

Settings

- ▶ Network
- ▶ System
- ▶ Notified Applications
- ▶ Access Control
- ▶ Time
- ▶ Firmware upload

Other languages

- ▶ See Dell web site

UPS Properties Help

The UPS Properties page is the default page and displays the basic status of the UPS.

At the top of the page, the UPS is identified: image, name and location.

The alarm icon above the UPS image displays if an alarm status. When it is:

- Red** - select it to see the current alarm page.
- Green** - no alarm is currently active.

An electrical diagram of the UPS displays the main parts of the UPS and shows the electrical flow that powers the load.

Note: The electrical diagram is not available for a line-interactive UPS.

A second segment of the page refreshes every 10 seconds and displays information determined by your selections in the combo box:

UPS Status selects the main status of the UPS:

Power source displays where the power originates

Output load level displays the load level.

Output displays the status of all UPS outputs.

UPS Alarms displays all the active alarms for the UPS.

UPS Metrics displays information related to UPS consumption (in watts). For each parameter, the user is allowed to reset the timestamp:

- Peak Consumption** displays the maximum consumed power in watts (since the last reset).
- Cumulative Peak** displays the cumulative consumed power in watts (since the last reset).
- Peak Headroom** displays the minimum remaining power in watts (since the last reset). The real time headroom value is displayed in the synoptic.

About your UPS displays static information to identify the UPS and the NMC card.

Figure 15. Online Help Example

UPS Properties

Essential information about the UPS status is available on the UPS Properties page (see Figure 16), which refreshes automatically every ten seconds.

The UPS Properties page shows an image and generic name of the UPS. You can customize the default location **Computer Room** to name the location of your system (see “System Settings” on page 52).

The screenshot shows the 'UPS Properties' page in the Dell UPS Management Card. The page is titled 'UPS Status' and 'UPS Properties'. It features a navigation menu on the left with sections for 'UPS', 'Logs and Notification', and 'Settings'. The main content area displays the following information:

- UPS Properties:** Dell UPS Tower 1920W HV, Computer Room
- UPS Status:** AC Power
- Output load level:** 0%
- Output:** Inverter: On, Load Segment 1: On, Load Segment 2: On
- Battery:** Battery charge level: 99% Resting
- Remaining backup time:** 6 h 25 min 31 s
- Battery status:** OK
- Last update:** 2009-09-09 18:08:28

A diagram titled 'Current UPS Operating Mode Diagram' shows a power flow from AC input through a rectifier, inverter, and output filter to the load. The battery is shown as a backup power source.

Figure 16. UPS Properties Page

UPS Measurements Detail

Place the cursor over the diagram to display the UPS measurements detail (see Figure 17). These measurements are available for Normal mode, Battery mode, and Bypass mode. The available measurements depend on the UPS model.

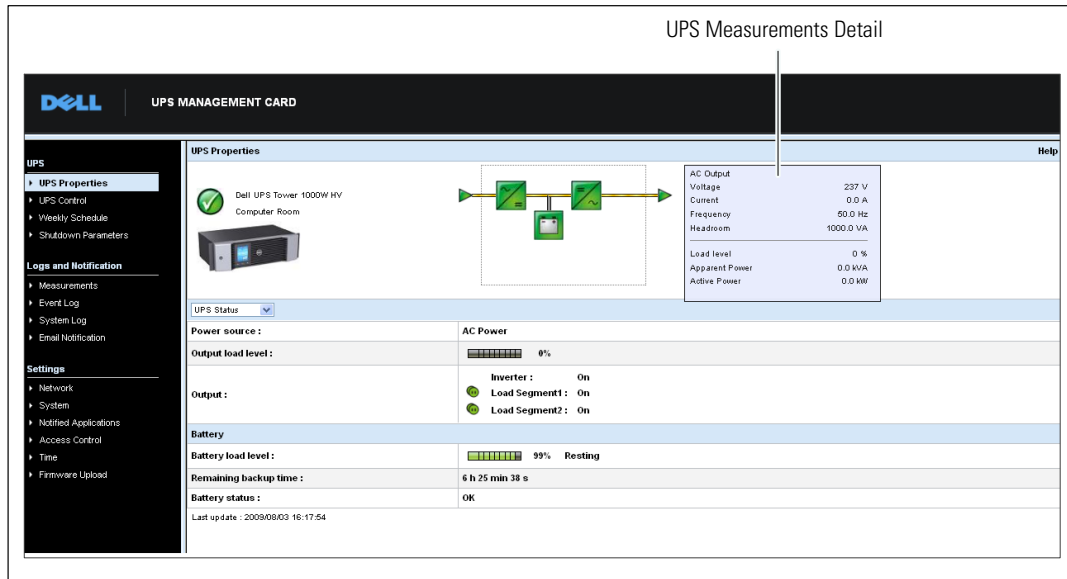





Figure 17. UPS Measurements Detail

UPS Status Icons

Table 3 lists the UPS status icons.

Table 3. UPS Status Icons

Icon	Description
 Green	Normal operation
 Red	Alarm present This icon links directly to the alarm page
 Gray	Loss of communication with the UPS

Diagrams display examples of the UPS current operating mode (see Table 4).

 **NOTE:** If communication with the UPS is lost, all diagrams appear gray.

Table 4. Operating Mode Diagrams

Operating Mode	Diagram
UPS with Automatic Bypass	 A schematic diagram of a UPS in Automatic Bypass mode. It shows an input line on the left and an output line on the right. The main power path consists of two green square inverters: the first has a tilde symbol (~) and an equals sign (=), and the second has an equals sign (=) and a tilde symbol (~). A battery symbol (a rectangle with a plus sign) is connected to the midpoint between the two inverters. A bypass switch, represented by a gray rectangle with a triangle and a diagonal line, is connected to the output of the second inverter. The bypass switch is shown in a closed position, allowing power to flow directly from the input to the output through the bypass path.
UPS without Automatic Bypass	 A schematic diagram of a UPS without an automatic bypass feature. It shows an input line on the left and an output line on the right. The main power path consists of two green square inverters: the first has a tilde symbol (~) and an equals sign (=), and the second has an equals sign (=) and a tilde symbol (~). A battery symbol (a rectangle with a plus sign) is connected to the midpoint between the two inverters. There is no bypass switch shown in this diagram.

Table 5 lists all the elements that can appear in a UPS operating mode diagram.

Table 5. Diagram Elements





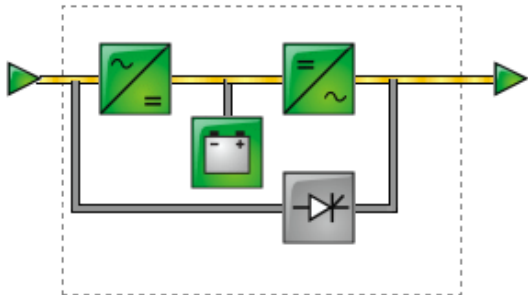
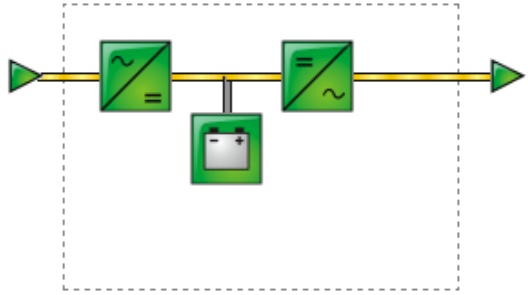





Type	Icons	Description
AC Normal Input	 Green	In tolerance
	 Gray	Out of tolerance
AC Normal Flow	 Yellow	AC to DC converter powered by normal AC
	 Gray	AC to DC converter not powered by normal AC
AC to DC Converter	 Green	Powered
	 Gray	Not powered
	 Red	Internal failure
Battery	 Green	Remaining capacity > 50%
	 Yellow	Remaining capacity ≤ 50%
	 Red	Battery to be checked (battery test result)

Table 5. Diagram Elements (continued)





















Type	Icons	Description
Battery Output Flow	 Yellow	AC to DC converter powered by battery
	 Gray	AC to DC converter not powered by battery
DC to AC Converter Input Flow	 Yellow	Energy flow present
	 Gray	No energy flow
DC to AC Converter	 Green	Powered
	 Gray	Not powered
	 Red	Internal failure
DC to AC Converter Output Flow	 Yellow	Energy flow present
	 Gray	No energy flow
AC Bypass Input	 Green	In tolerance
	 Red	Out of tolerance
AC Automatic Bypass Flow	 Yellow	Energy flow present
	 Gray	No energy flow

Table 5. Diagram Elements (continued)

Type	Icons	Description
AC Automatic Bypass Status	 Green	Powered
	 Gray	Not powered
	 Red	Internal failure
AC Output Flow	 Yellow	Energy flow present
	 Gray	No energy flow
AC Output	 Green	Load protected
	 Red	Load not protected

UPS Status List

Select an item from the UPS Status list to view specific information about the UPS (see Figure 18). Table 6 lists the items available. The following sections describe each item in detail.

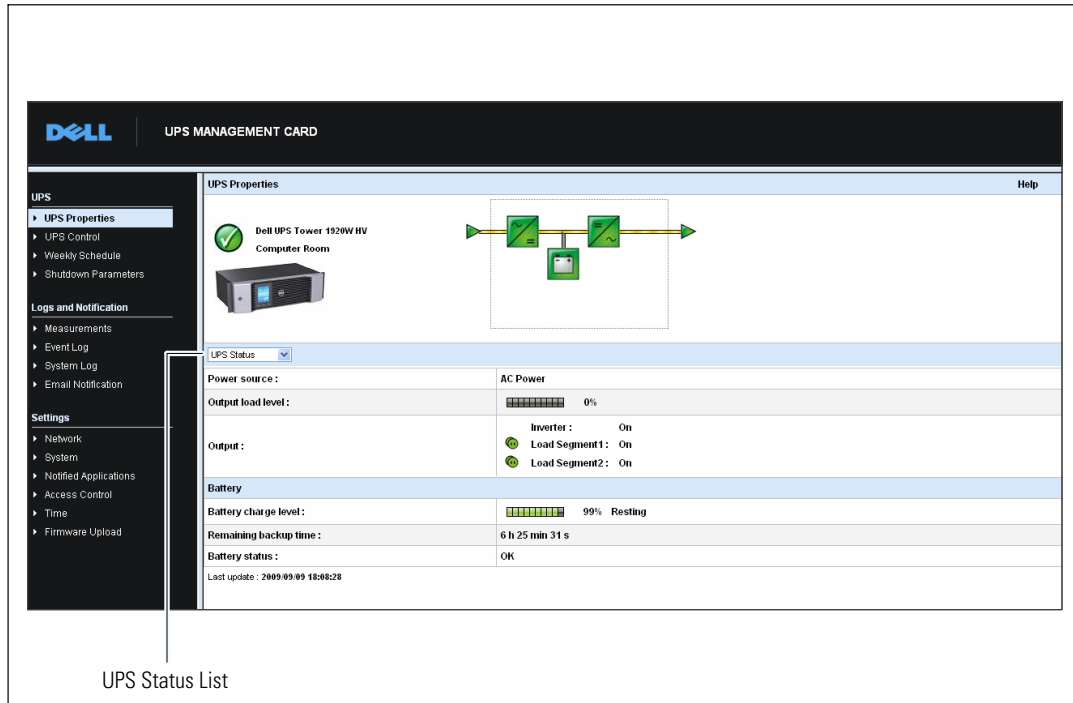

UPS Status List

Figure 18. UPS Status List (Default UPS Status View Shown)

Table 6. UPS Status List



Item	Description
UPS Status	(Default view) Provides essential information about the power status of the UPS
UPS Alarm	Displays a list of current alarms
UPS Metrics	Displays information about power consumption
About Your UPS	Provides information about the model and firmware version of the UPS and the card

UPS Status

The UPS Status view displays the following basic information about power and output:

- **Power source:** Indicates whether power comes from the utility or from the UPS battery.
- **Output load level:** Indicates the power percentage used at UPS output.
- **Output:** Indicates whether the individual UPS outputs are protected.
 - **Inverter (UPS):** Indicates whether the UPS main output is protected.
 - **Load Segment 1 and Load Segment 2:** Indicates whether the controlled load segments (if available) are powered (see Table 7).

Table 7. UPS Output Status

Element	Description
 Green	Receptacle powered
 Red	Receptacle not powered or not protected

- **Battery charge level:** Remaining battery charge (in percent). Battery modes are:
 - **Fault:** The battery is faulty.
 - **No Battery:** No battery found.
 - **Charging:** The utility power is present and the battery charge is in progress.
 - **Discharging:** The UPS is operating on battery.
 - **Floating:** The battery is at optimum charge level.
 - **Resting:** The battery is not charging.

 **NOTE:** The battery has reached the end of the Floating mode time period and has stopped charging to extend the life of the battery. The battery slowly discharges until the minimum charge level is reached. When the minimum charge level is reached, the battery returns to Charging mode.

 - **Charger disabled:** Battery charger is off.
- **Remaining backup time:** Estimate of the battery's maximum backup time remaining before UPS shutdown.
- **Battery status:** Result of the last automatic battery test carried out by the UPS. Possible values are:
 - **OK:** The test completed correctly.
 - **NOK:** The battery needs to be checked.
 - **Deactivated:** The automatic battery test was not validated on the UPS.

View Current Alarms

Select **UPS Alarms** from the UPS Status list to display the list of current alarms (see Figure 19). Table 8 lists the alarm severity levels. Table 9 and Table 10 list the managed UPS and system alarms.

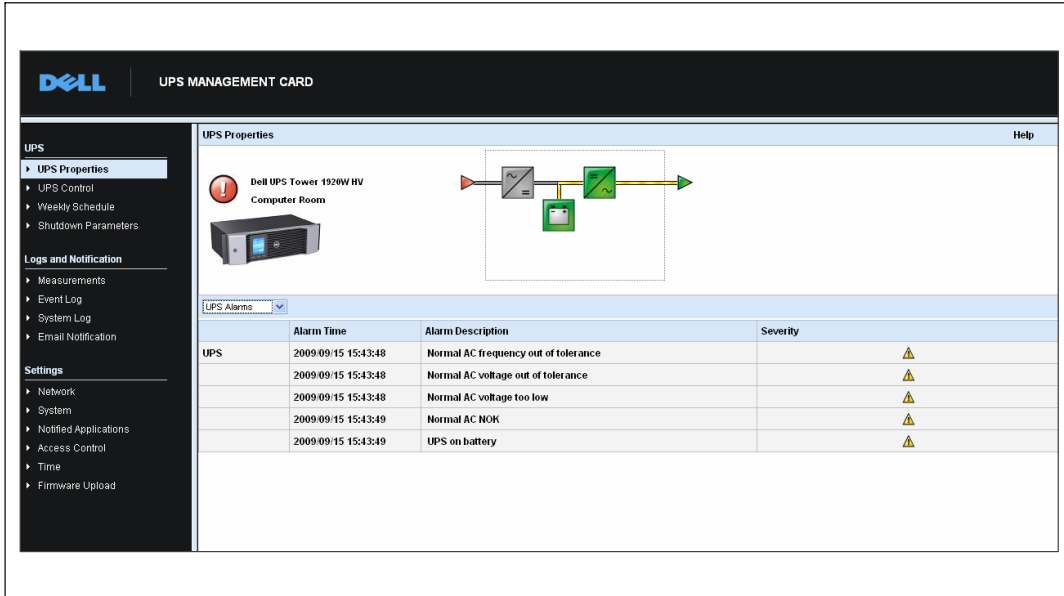

Figure 19. UPS Alarms Display

Table 8. Severity Levels



Icon	Level
 Red	Critical
 Yellow	Warning
 Gray	Unknown

Table 9. UPS Alarms

Alarm On	Alarm Off
Battery fuse blown	Battery fuse OK
No Battery	Battery present
Battery temperature fault	Battery temperature OK
Battery charger fault	Battery charger OK
Battery fault	Battery OK
MAX charger voltage fault	Charger voltage OK
MIN charger voltage fault	Charger voltage OK
Charger temperature fault	Charger temperature OK
Rectifier fault	Rectifier OK
Chopper fault	Chopper OK
Normal AC frequency out of tolerance	Normal AC frequency OK
Normal AC fuses blown	Normal AC fuses OK
Normal AC module fault	Normal AC module OK
Normal AC voltage out of tolerance	Normal AC voltage OK
Normal AC NOK	Normal AC OK
Site wiring fault	Site wiring OK
Bypass AC frequency out of tolerance	Bypass AC frequency OK
Bypass AC phase out of tolerance	Bypass AC phase OK
Bypass AC voltage out of tolerance	Bypass AC voltage OK
Automatic Bypass fault	Automatic Bypass OK
Automatic Bypass overload	Automatic Bypass load OK
Automatic Bypass overtemperature	Automatic Bypass temperature OK
Automatic Bypass thermal overload	Automatic Bypass load OK
Normal AC switch (Q1) open	Normal AC switch (Q1) closed
Negative DC bus too high	Negative DC bus OK
Positive DC bus too high	Positive DC bus OK
Negative DC bus too low	Negative DC bus OK
Positive DC bus too low	Positive DC bus OK
Inverter limitation	Inverter end of limitation
Inverter fuses blown	Input fuses OK
Inverter fault	Inverter OK

Table 9. UPS Alarms (continued)

Alarm On	Alarm Off
Inverter overload	Inverter load OK
Inverter over temperature	Inverter temperature OK
Inverter short circuit	Inverter OK
Inverter thermal overload	Inverter load OK
Load not protected - On Automatic Bypass	Load protected - Return from Bypass
Load short circuit	Load OK
Load not powered	Load powered
Protection Lost	Protection OK
Emergency button ON	Emergency button OFF
Fan fault	Fan OK
Redundancy Lost	Redundancy OK
Low battery	Battery OK
UPS communication failed	UPS communication restored
UPS data base not available	UPS data base OK
UPS on battery	UPS on normal AC
UPS internal fault	UPS OK
UPS overload L1	UPS overload Level 1 cleared
UPS overload L3	UPS overload Level 2 cleared
UPS overload L3	UPS returns to normal load
UPS overtemperature	UPS temperature OK
Imminent UPS shutoff	UPS OK
UPS exceeds current threshold	UPS returns to normal current
Battery high voltage fault	Battery voltage OK
Normal AC voltage too high	Normal AC voltage OK
Normal AC voltage too low	Normal AC voltage OK
Inverter voltage too high	Inverter voltage OK
Inverter voltage too low	Inverter voltage OK
UPS configuration fault in memory	UPS configuration OK
ABM state floating	ABM state Off
ABM state charging	ABM state Off
ABM state resting	ABM state Off

Table 9. UPS Alarms (continued)

Alarm On	Alarm Off
On buck	Return from buck
On boost	Return from boost

Table 10. System Alarms

Dell Network Management Card startup
Send test mail SUCCESS
Send test mail ERROR
Send mail to <recipient> ERROR
Firmware upgraded
sendTrap() -> Unable to resolve hostname <hostname>
SNMP Send Trap # <num> failure to <hostname>

View Power Consumption

Select UPS Metrics from the UPS Status list to display levels of power consumption (see Figure 20) for the following:

- **Peak Consumption:** Indicates the last peak of consumption since the last reset.
- **Cumulative Consumption:** Indicates the consumption computed since the last reset.
- **Peak Headroom:** Indicates the most recent peak headroom level since the last reset. The real time headroom value is shown in the diagram.

You can reset the time stamp for each parameter.

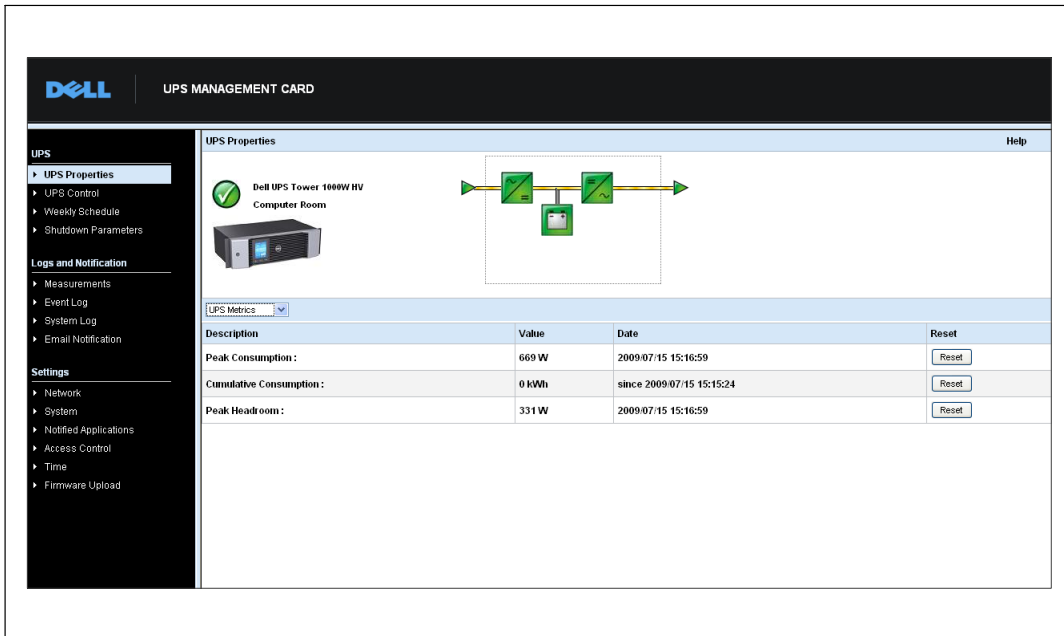
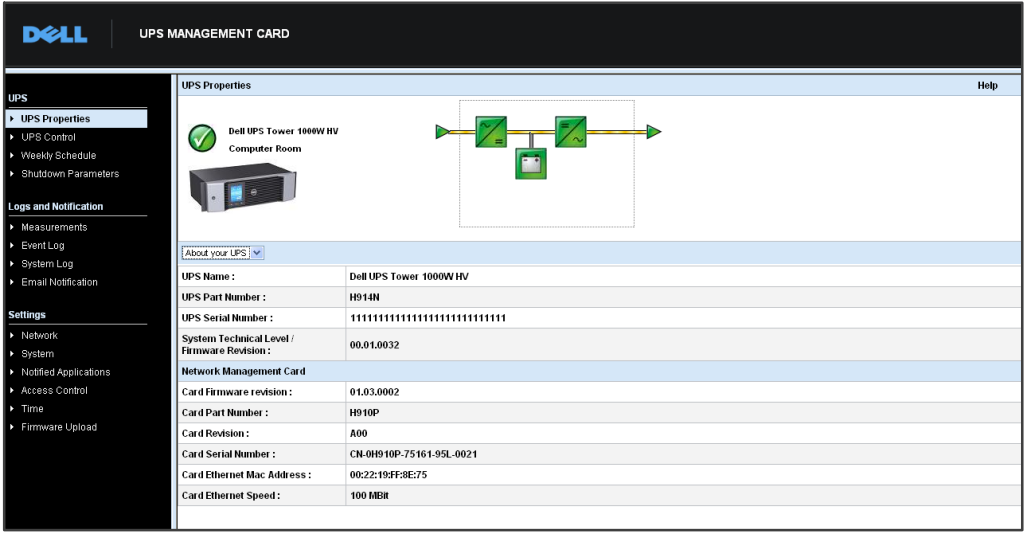

Figure 20. UPS Metrics Display

View UPS and Card Information

Select **About Your UPS** from the UPS Status list to display information about the UPS and the card (see Figure 21).



The screenshot displays the Dell UPS Management Card interface. On the left is a navigation menu with sections for UPS, Logs and Notification, and Settings. The main area is titled 'UPS Properties' and shows a 'Dell UPS Tower 1000W HV' in a 'Computer Room' with a status icon and a diagram of the UPS system. Below this is a table with the following data:

About your UPS	
UPS Name :	Dell UPS Tower 1000W HV
UPS Part Number :	H914N
UPS Serial Number :	11111111111111111111111111111111
System Technical Level / Firmware Revision :	00.01.0032
Network Management Card	
Card Firmware revision :	01.03.0002
Card Part Number :	H910P
Card Revision :	A00
Card Serial Number :	CN-0H910P-75161-95L-0021
Card Ethernet Mac Address :	00:22:19:FF:8E:75
Card Ethernet Speed :	100 MBR

Figure 21. About Your UPS Display

UPS Control

Click UPS Control from the menu bar to open the UPS Control page (see Figure 22).

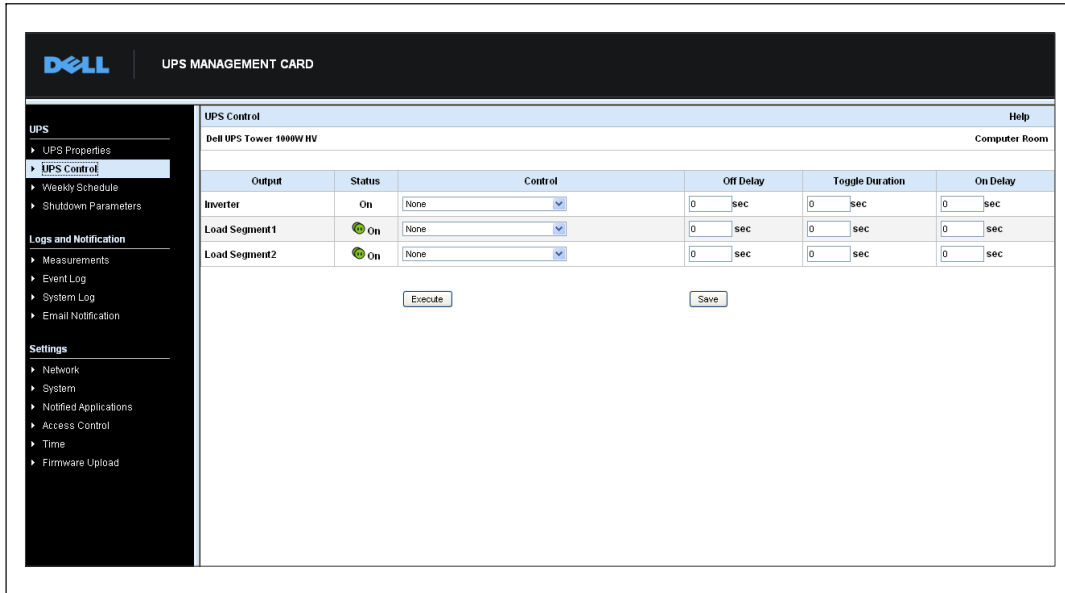

Figure 22. UPS Control Page

The UPS Control page enables triggering of startup and shutdown sequences for the UPS main output and load segments.

The status of each output displays by a icon associated with the Off label (red icon) or On label (green icon).

The shutdown sequences allow time for the registered servers to shut down without losing data (see “Shutdown Parameters” on page 40).

The Inverter has priority over the load segments. Shutdown of the Inverter causes the load segments to shut down. Load segments can be started only if the Inverter is on.

The list in the Control column displays the following commands, which are initialized by clicking **Execute**. These commands include:

- **Safe power down:** Immediately launches a sequence to switch off output power. The command shuts down the supplied systems while the shutdown sequence is running, then switches off the output.

- **Safe power down & reboot:** Immediately launches a sequence to switch off and then restore output power. It shuts down the powered systems during the shutdown sequence, and then switches off the output. Finally, it launches the restart sequence at the end of the time delay specified in the **Toggle duration** parameter. The output status is updated.
- **Immediate On:** Immediately launches a sequence to switch on output power . It re-powers the output and starts the systems.
- **Delayed, safe power down:** This is the same switch off sequence as for the **Safe power down** command, but postponed by the number of seconds programmed in the **Off Delay** parameter.
- **Delayed, safe power down & reboot:** This is the same switch off and then on sequence as for the **Safe power down & reboot command**, but postponed by the number of seconds programmed in the **Off Delay** parameter.
- **Delayed On:** This is the same switch on sequence as for the **Immediate On** command, but postponed by the number of seconds programmed in the **On Delay** parameter.

Selecting **Save** saves the **Off Delay**, **Toggle duration**, and **On Delay** parameters on the card.



NOTE: For security purposes, the administrator must click **Save** and enter the admin user name and password to save modifications or run commands. The default user name and password are both **admin**.

UPS Weekly Schedule Programming

Click Weekly Schedule from the menu bar to set up the timing of specific weekly actions (see Figure 23).

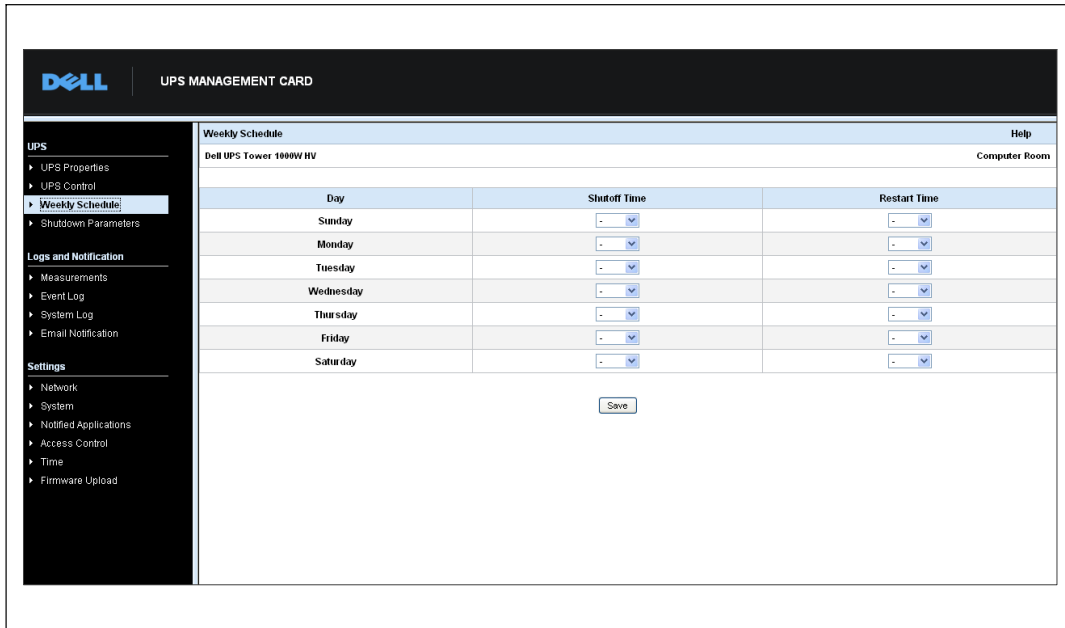

Figure 23. Weekly Schedule Page

NOTE: UPS configuration can prevent the shutdown and restart commands from being run properly. Refer to the UPS user's manual for more information.

The weekly schedule enables the administrator to optimize power consumption or program a reboot of the protected equipment at a set time.

In a shutdown sequence, the Dell UPS Management Software connected to the card is informed, ensuring that each machine is shut down correctly before the UPS output is switched off. You can program up to seven UPS shutdown sequences in one week, with a minimum shutdown delay of 30 minutes.

The On/Off sequences are valid only if the card's time has been set properly.

NOTE: For security purposes, the administrator must click Save and enter the admin user name and password to save modifications or run commands. The default user name and password are both admin.

Shutdown Parameters

Click **Shutdown Parameters** from the menu bar to view and configure UPS operating parameters in battery mode and for power restoration (see Figure 24).

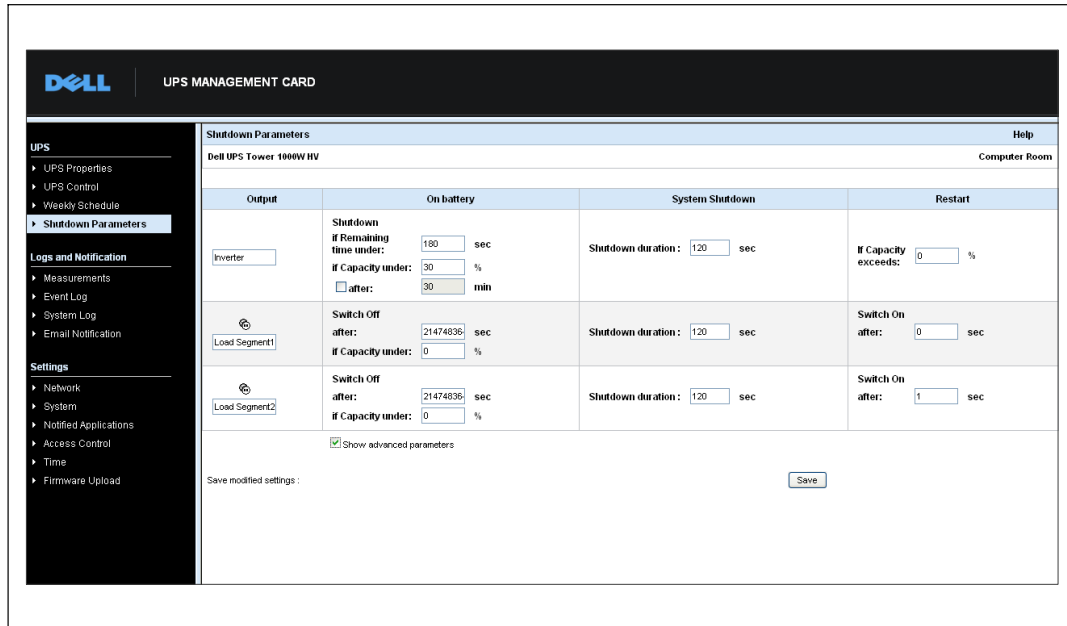



Figure 24. Shutdown Parameters Page (Advanced Parameters Shown)

Click **Show advanced parameters** to display additional parameters for adjusting specific thresholds related to the percentage of remaining battery charge level.

The Output column allows each receptacle to be named (maximum 20 characters).

Since priority is given to the main receptacle, the card cannot supply power to the load segments when the main receptacle power is off.

 **NOTE:** For security purposes, the administrator must click **Save** and enter the admin user name and password to save modifications or run commands. The default user name and password are both admin.

UPS Shutdown (Inverter)

The first shutdown criterion initiates the restart of the shutdown sequence if the remaining time is under (0 to 99999 seconds, 180 by default). This value is the minimum remaining backup time before the shutdown sequence is launched.

- **If battery capacity is under (0 to 100%):** This value cannot be less than that of the UPS and is the minimum remaining battery capacity level before the shutdown sequence launches.
- **Shutdown after (0 to 99999 minutes, not validated by default):** This value is the operating time in minutes left for users after a switch to backup before starting the shutdown sequence.
- **Shutdown duration (120 seconds by default):** This value is the time required for complete shutdown of systems when a switch to backup time is long enough to trigger the shutdown sequences. It is calculated automatically at the maximum of **Shutdown duration of subscribed clients**, but can be modified in the Advanced mode.
- **If battery capacity exceeds:** This value is the minimum battery level to reach before restarting the UPS after utility is restored.

Load Segments Shutdown

 **NOTE:** Some UPSs do not support the load segments control feature.

To program the operation time and level in backup mode to manage receptacle load shedding in the event of electric power failure, set the following parameters:

- **Switch Off after (from 0 to 99999 seconds, 65535 by default):** The time during which the load segment is supplied starting from the moment of utility failure.

 **NOTE:** The Switch Off after time value includes the load segment shutdown duration.

- **Switch Off if battery capacity under (0 by default):** An extra condition for load segment shutdown that can trigger the shutdown sequence before the shutdown duration runs out.
- **Shutdown duration:** The time required for complete shutdown of the systems supplied by the load segment when a load segment shutdown sequence launches.
- **Switch On after (from 0 to 99999 seconds, 65535 by default):** The period between main output startup and startup of the relevant programmable load segment; therefore load segment startup can be delayed in relation to the main output.

 **NOTE:** Some UPSs do not support the Switch On after option.

Measurements

Click Measurements from the menu bar to view the measurements for the UPS (see Figure 25).

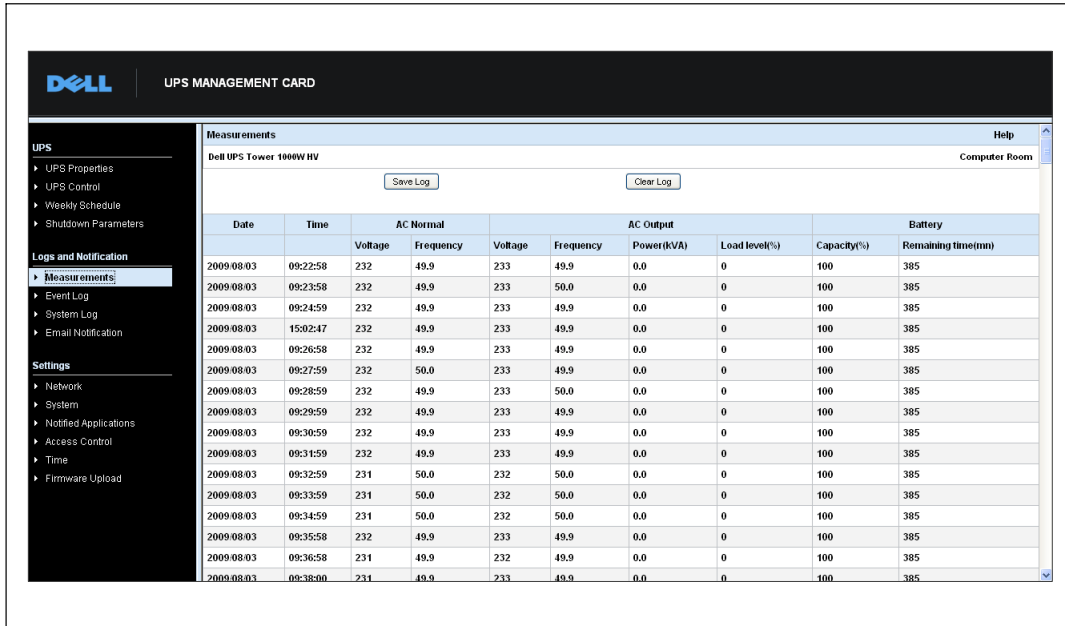

Figure 25. Measurements Page

The following measurements are saved and time-stamped:

- **AC Normal Voltage:** Value of the utility voltage supplying the UPS
- **AC Normal Frequency:** Value of the utility frequency supplying the UPS
- **AC Output Voltage:** Value of the UPS output voltage
- **AC Output Frequency:** Value of the UPS output frequency
- **AC Output Power (kVA):** Value of the UPS output power
- **AC Output Load level (%):** Value of the percentage of load at UPS output
- **Battery Capacity (%):** Percentage of charge available in the battery
- **Battery Remaining time (min):** Estimate of the remaining backup time

The save frequency of these values (60 seconds by default) is defined on the System page (see “System Settings” on page 52). Approximately 435 time-stamps can be stored on the card. When the system exceeds this threshold, the oldest time-stamps are deleted automatically.

Save Log enables you to open or save all saved values in comma separated values (CSV) format (compatible with Microsoft Excel type spreadsheets).

Clear Log enables you to delete all records. Enter the user name and password to validate this action.

Event Log

Click **Event Log** from the menu bar to view logged events (see Figure 26).

The screenshot displays the 'Event Log' page for a Dell UPS Management Card. The page title is 'UPS MANAGEMENT CARD' and the specific device is 'Dell UPS Tower 1000W HV' located in 'Computer Room'. There are 'Save Log' and 'Clear Log' buttons. A table lists the following events:

Date	Time	Event Description
2009.08.03	15:44:30	Normal AC NOK
2009.08.03	15:44:30	UPS on battery
2009.08.03	15:44:31	System shutdown in 4 h 28 mn 52 s
2009.08.03	15:44:31	Outlet group 1 shutdown in 4 h 28 mn 52 s
2009.08.03	15:44:31	Outlet group 2 shutdown in 4 h 28 mn 52 s
2009.08.03	15:44:32	Normal AC frequency out of tolerance
2009.08.03	15:44:32	Normal AC voltage out of tolerance
2009.08.03	15:44:32	Normal AC voltage too low
2009.08.03	15:44:38	Normal AC OK
2009.08.03	15:44:40	Normal AC frequency OK
2009.08.03	15:44:40	Normal AC voltage OK
2009.08.03	15:44:41	UPS on normal AC

Figure 26. Event Log Page

The card can save up to 435 events. When this threshold is exceeded, the system deletes the oldest event when a new one occurs.

Save Log enables you to save values in CSV format.

Clear Log enables you to delete all records. Enter the admin user name and password to validate this action.

 **NOTE:** See Table 9 and Table 10 starting on page 32 for a list of managed alarms.

System Log

Click **System Log** from the menu bar to view system events (see Figure 27). The card can save up to 435 events. When this threshold is exceeded, the system deletes oldest event when a new one occurs.

Save Log enables you to save values in CSV format.

Clear Log Enables you to delete all records. Enter the admin user name and password to validate this action.

 **NOTE:** See Table 9 and Table 10 starting on page 32 for a list of managed alarms.

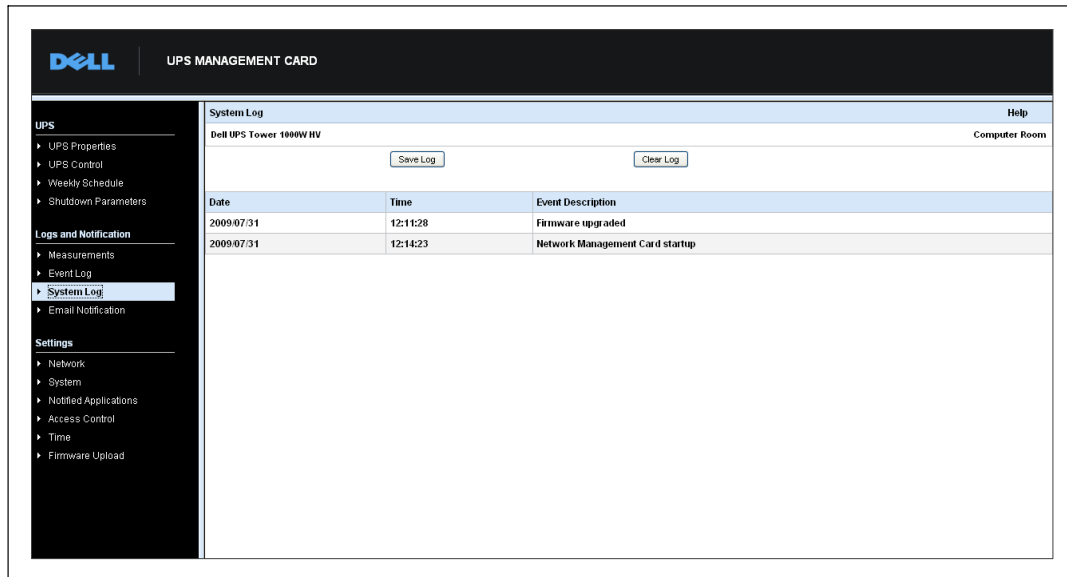

Figure 27. System Log Page

Notification

E-Mail Notification

The card can redirect UPS alarms to an e-mail server to distribute information to the appropriate recipients. The format of these e-mail messages is compatible with mobile telephone transfer systems using the short message service (SMS) standard for text messaging.

Click **Email Notification** from the menu bar to configure e-mail recipients (see Figure 28).

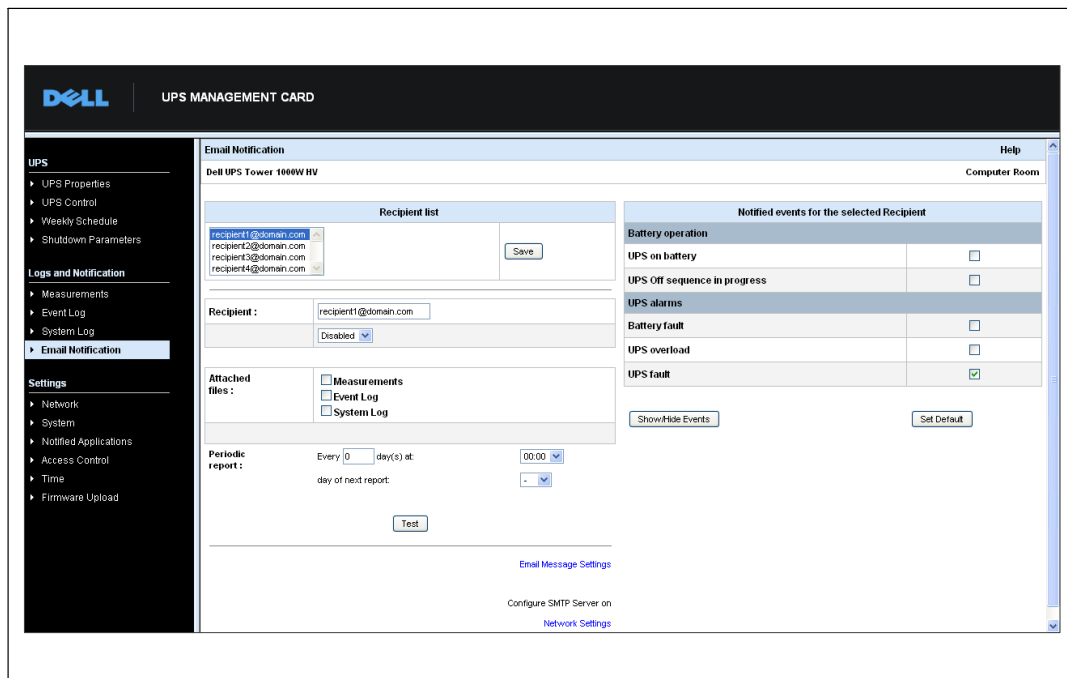

Figure 28. Email Notification Page

On the E-mail Notification page, you can configure up to four recipients in the Recipient list to receive e-mail messages initiated by the card. Each recipient receives an e-mail message based on specific trigger events, selected from the right side of the page. The card's log also indicates e-mail transmission errors.

Each recipient is configured with the following parameters:

- **Recipient (limited to 99 characters):** The e-mail address of the person or department to receive the e-mail.
The default value is recipienttx@domain.com. The files are sent in CSV format.
- **Attached files:** The files selected (Measurements, Event log, System log) are attached to the e-mail message.
- **Periodic report:** In addition to the e-mail messages sent when events occur, you can send to the recipient at specified intervals a periodic e-mail message with the three log files attached. To configure the first transmission, specify the day, time, and frequency of the next transmission. After this date, the page shows the date and time of the next transmission. Data is sent in CSV format.
- **E-mail Message Settings:** Access to the message configuration page (see “E-Mail Message Settings” on page 47).
- **Network Settings:** Enables you to enter the name of the SMTP server (see “Network Settings” on page 49).
- **Test:** Enables you to send an e-mail message to the recipient immediately. Use this method to check e-mail transmission—particularly to check access to the SMTP server configured in the Network settings (see “Network Settings” on page 49). A transmission report is added to the system log. The event label in the subject and text of the message is replaced with a test label. If you make any modifications to the page, you must save them before using the Test function.
- **Save:** Saves any modifications.

The right side of the page shows the events that can require notification. By default, only main events, such as battery operation and a few of the UPS alarms, are accessible. All the events appear if the Show/Hide Events option is selected. By default, only two events are selected for notification: **UPS Off sequence in progress** and **UPS alarms**. You can modify this pre-selection by clicking on other events. You can restore the initial configuration by clicking **Set Default**.

For security purposes, you must click **Save** and enter the admin user name and password to preserve any modifications. By default, the user name and password are both **admin**.

E-Mail Message Settings

Use the Email Message Settings page to customize the content of e-mail messages initiated by the card (see “Email Notification” on page 45). See Figure 29.

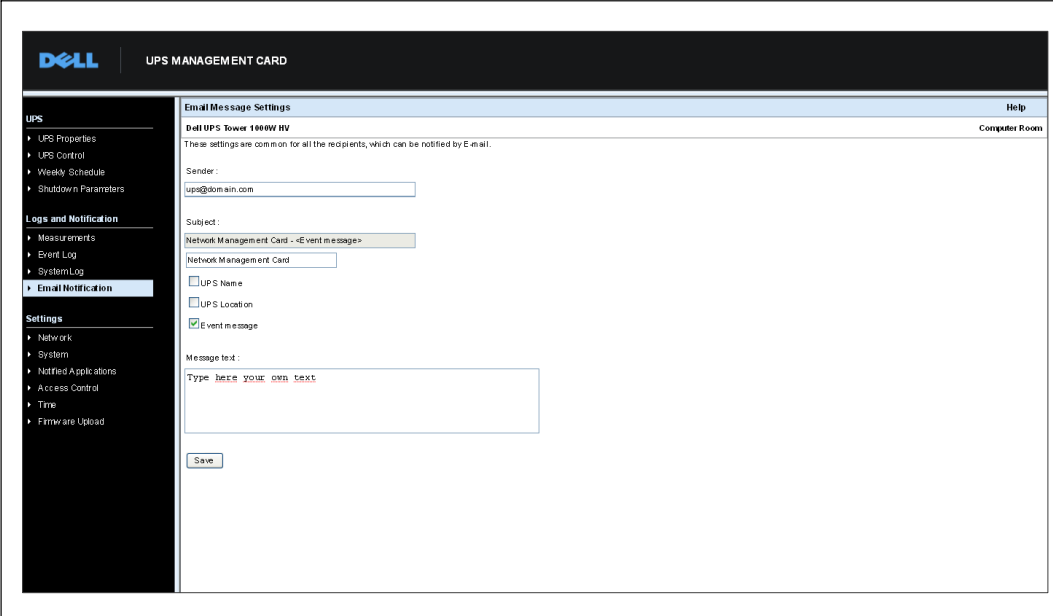

The screenshot shows the Dell UPS Management Card interface. The top navigation bar includes the Dell logo and the text "UPS MANAGEMENT CARD". A left-hand sidebar menu lists various settings categories: UPS (Properties, Control, Schedule, Shutdown Parameters), Logs and Notification (Measurements, Event Log, System Log, Email Notification), and Settings (Network, System, Notified Applications, Access Control, Time, Firmware Upload). The "Email Notification" option is selected. The main content area is titled "Email Message Settings" and includes a "Help" link. Below the title, it specifies the device as "Dell UPS Tower 1600W RV" and the location as "Computer Room". A note states: "These settings are common for all the recipients, which can be notified by E-mail." The form contains the following fields and options: "Sender:" with a text input field containing "ups@domain.com"; "Subject:" with a text input field containing "Network Management Card - <Event message>" and a dropdown menu currently showing "Network Management Card"; three checkboxes: "UPS Name" (unchecked), "UPS Location" (unchecked), and "Event message" (checked); and "Message text:" with a large text area containing the placeholder "Type here your own text". A "Save" button is located at the bottom of the form.

Figure 29. Email Message Settings Page

Common settings for all e-mail message recipients follow:

- **Sender (59 characters maximum):** Identifies the source of the message. The default value is ups@domain.com.

This field allows free text. However, depending on the SMTP server configuration, the server may check that the domain name contained in the Sender address exists and that the user in the Sender address belongs to this domain.

- **Subject:** Identifies the subject of the e-mail message to be sent. Enter text and select from the following optional check boxes to build the message subject:
 - **UPS Name** specifies the name of the UPS.
 - **UPS Location** displays the geographic location of the UPS (see “System Settings” on page 52).
 - **Event Message** identifies the event generating the e-mail message.

- **Message text:** Allows a maximum of 255 characters.

As shown in Figure 30, the body of the e-mail message contains:

- Message text
- The date and time of the event, as saved in the log
- URL of the card, enabling a direct link with the card to be established
- Attachments, as configured for the e-mail recipients
- Duplication of the subject, if configured

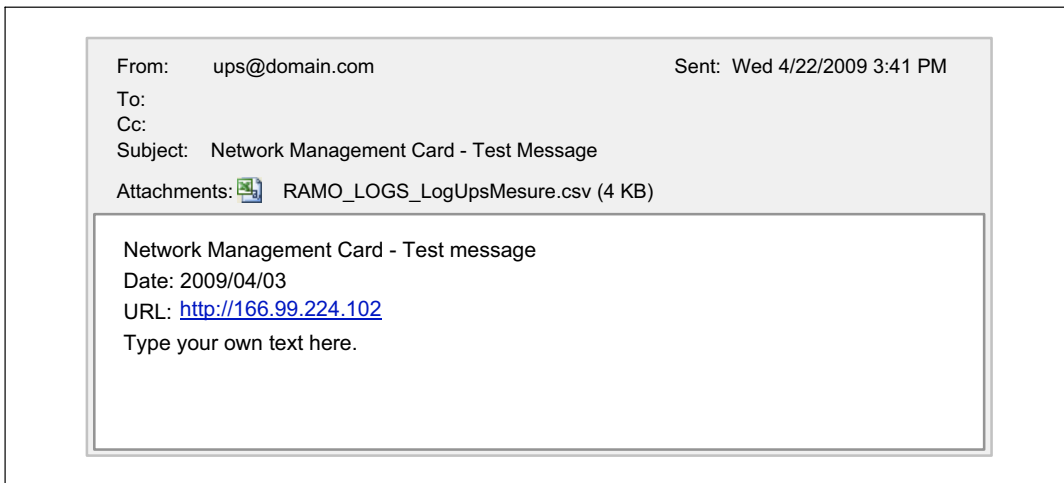

Figure 30. E-Mail Message Example

Sending Text Messages

The card can redirect UPS alarms to an e-mail server. The format of these e-mail messages is compatible with mobile telephone e-mail/SMS transfer systems used by Internet Service Providers (ISPs). The format to be used depends on the service provider.

Network Settings

Click **Network** from the menu bar to configure the network parameters of the card and authorize the remote upgrade of the embedded system (see Figure 31).

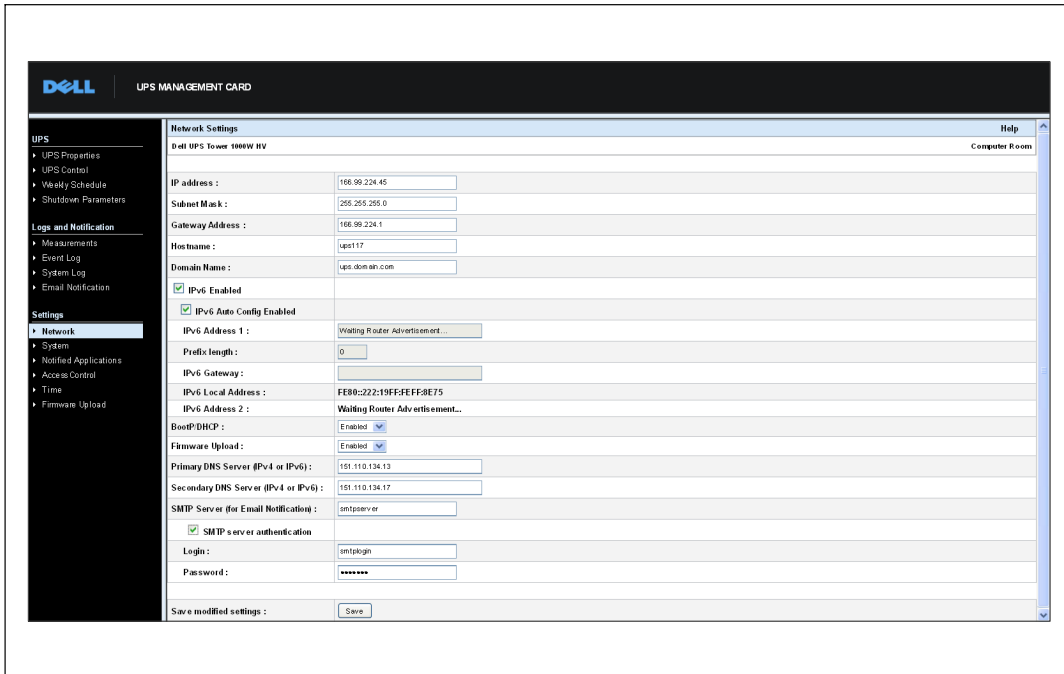

Figure 31. Network Settings Page

Configurable network settings are:

- **IP Address:** The IP address of the card (for example, 166.99.224.70).
- **Subnet Mask:** The mask of the sub-network of your network (for example, 255.255.255.0).
- **Gateway Address:** The IP address of the gateway to access the stations located outside the card's subnet (for example, 166.99.224.1).
- **Hostname:** The host name of the card. First part of the fully qualified domain name used by the Domain Name System (DNS).

Because the card does not support NetBIOS protocol, the hostname is sent to DNS only if the DHCP server sends the hostname with the new IP address. This mechanism is described in the update of the DNS protocol RFC 2136.

- **Domain Name:** The domain to which the card belongs. The domain name is the part of the fully qualified domain name that follows the hostname and is used by the DNS. The default value of the two parameters comprising the fully qualified domain name: **ups.domain.com**.

- **IPv6 Enabled:** When selected, Internet Protocol version 6 (IPv6) features are enabled.



NOTE: IPv6 is described in the Internet standard RFC 2460.

- **IPv6 Auto Config Enabled:** Select this option to have the following IPv6 parameters automatically generated by the card or the IPv6 DHCP server (if an IPv6 DHCP server is available on the network):

- Local IPv6 address
- Prefix length

The IPv6 Gateway becomes unavailable and remains blank.

- **IPv6 Address 1:** If **IPv6 Auto Config Enabled** is selected, the first IPv6 address displays.

If **IPv6 Auto Config Enabled** is not selected, the IPv6 address of the card can be entered in the following format:

- [::1:0:0 ; 1FFF:FFFF:FFFF:FFFF:FFFF:FFFF:FFFF:FFFF] for a range of prefix [4–128]
- [2000:: ; FEFB:FFFF:FFFF:FFFF:FFFF:FFFF:FFFF:FFFF] for a prefix of 64

- **Prefix length:** The addressing prefix used to route external traffic for a network.

If **IPv6 Auto Config Enabled** is selected, the IPv6 network prefix displays.

If **IPv6 Auto Config Enabled** is not selected, the IPv6 network prefix can be entered in the following format:

- [4-128] for an IP address 1:
[::1:0:0 ; 1FFF:FFFF:FFFF:FFFF:FFFF:FFFF:FFFF:FFFF]
- 64 for an IP address 1:
[2000:: ; FEFB:FFFF:FFFF:FFFF:FFFF:FFFF:FFFF:FFFF]

- **IPv6 Gateway:** If **IPv6 Auto Config Enabled** is selected, the IPv6 the field is blank and not available.

If **IPv6 Auto Config Enabled** is not selected, the name of the IPv6 Gateway can be entered.

- **IPv6 Local Address:** The IPv6 local address displays (the local address is generated from the card's MAC address).

- **IPv6 Address 2:** If **IPv6 Auto Config Enabled** is selected, the second IPv6 address is provided by the DHCP server (for example: 1876:720:410:100A:1111:2222:33:4444) and cannot be changed.

If **IPv6 Auto Config Enabled** is not selected, the field is blank and not available.

- **BootP/DHCP:** Authorizes (choose Enabled) configuration of network parameters with the BOOTP/DHCP server when the card is booted.

Mode of card operation with server: After each startup, the card makes five attempts to recover the network parameters. If it receives no response from the server, the card boots with the last saved parameters from the most recent start. These parameters are shown on the page. The default value for this parameter is **Enabled**.

 **NOTE:** If the hostname is not used, the IP address supplied by the DHCP server must be assigned through Static DHCP Assignment to maintain the connection with the clients installed on the stations to be protected.

 **NOTE:** During the first connection, if the DHCP query is not successful, the Dell Network Management Card starts with the following IP configuration:

IP Address: 192.168.1.2

Subnet Mask: 255.255.255.0

Gateway Address: 0.0.0.0

- **Firmware Upload:** Authorizes (choose Enabled) remote updating of the card's embedded software. The default value for this parameter is **Enabled**.
- **Primary DNS Server:** Contains the IP address of the main DNS server ensuring conversion of the domain name to IP address.
- **Secondary DNS Server:** Contains the IP address of the secondary DNS server ensuring conversion of the domain name to IP address if the primary DNS server is not available.
- **SMTP Server (for Email Notification):** Contains the name or IP address of the local server with which the card connects to send e-mail messages. You can fill in the field either as host + domain name (DNS resolution) or directly with the IP address.
The default value is smtpserver. The card uses the standard port (25) for sending e-mail messages.
- **SMTP server authentication (optional):** To select this option, enter the SMTP server user name and password.

For security purposes, you must click **Save** and enter the admin user name and password to save modifications or run commands. The default user name and password are both **admin**.

Reboot the card after any changes to these parameters (see the following section, “System Settings”).

System Settings

Click **System** from the menu bar to customize the information that displays on the UPS Properties page (see “UPS Properties Page” on page 23). The System Settings page opens (see Figure 32).

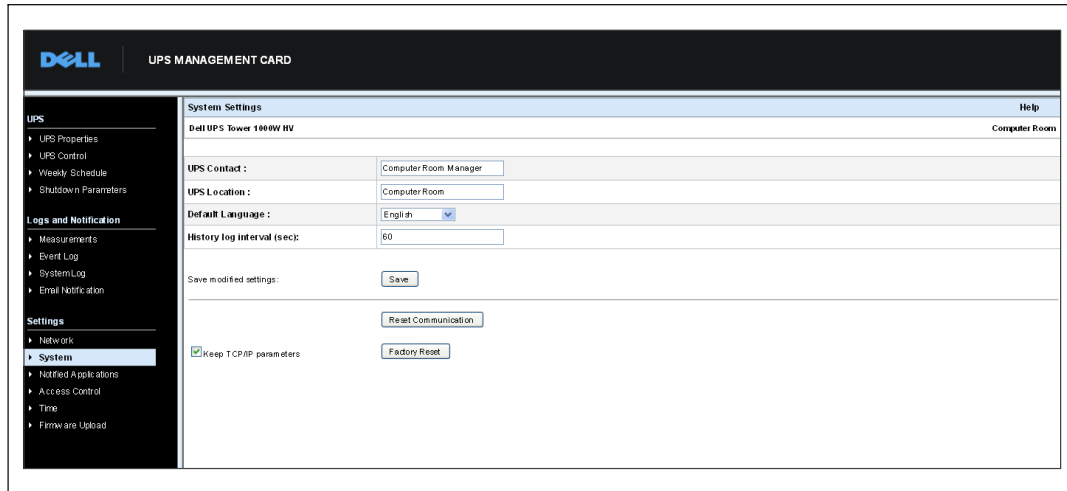

Figure 32. System Settings Page

Configurable system settings are:

- **UPS Contact:** This text field is limited to 49 characters. Enter the name of the person responsible for UPS administration at IT network level and/or electrical maintenance. This field does not appear on any other Web page. By default, its value is **Computer Room Manager**.
- **UPS Location:** Enter a description (limited to 31 characters) of the physical location of the UPS in your installation (for example, Computer Room E1-C066). This text displays on the home page. By default, its value is **Computer Room**.
- **Default Language:** Enables initialization of the browser language at card connection. Select one of the available languages (English, French, Spanish, German, Simplified Chinese, Japanese, Russian, Korean, or Traditional Chinese). To change the language of the Web interface pages, restart your browser after modification.
- **History log interval (sec):** Measurement save period. Values are from 5 to 99999 seconds, 60 seconds by default.
- **Save:** Saves any modifications.
- **Reset Communication button:** Performs a remote reboot of the card without modifying the configuration. This action is required for any changes you made on the Network Settings page. To ensure security, this operation requires admin user name and password.

- **Factory Reset button:** Restores the default configuration of all the card's parameters.
- **Keep TCP/IP parameters:** Select this option to maintain the IP address, subnet mask, gateway, and BOOTP/DHCP value. To ensure security, this operation requires admin user name and password. By default, user name and password are both **admin**.

Notified Applications

Use the Notified Applications page to modify a network management system (NMS) that is set to receive notifications from the card or to add up to three NMSs to the notified applications.

To modify or add a new NMS:

- 1 Select **Notified Applications** from the menu bar. The Notified Applications page opens (see Figure 33).

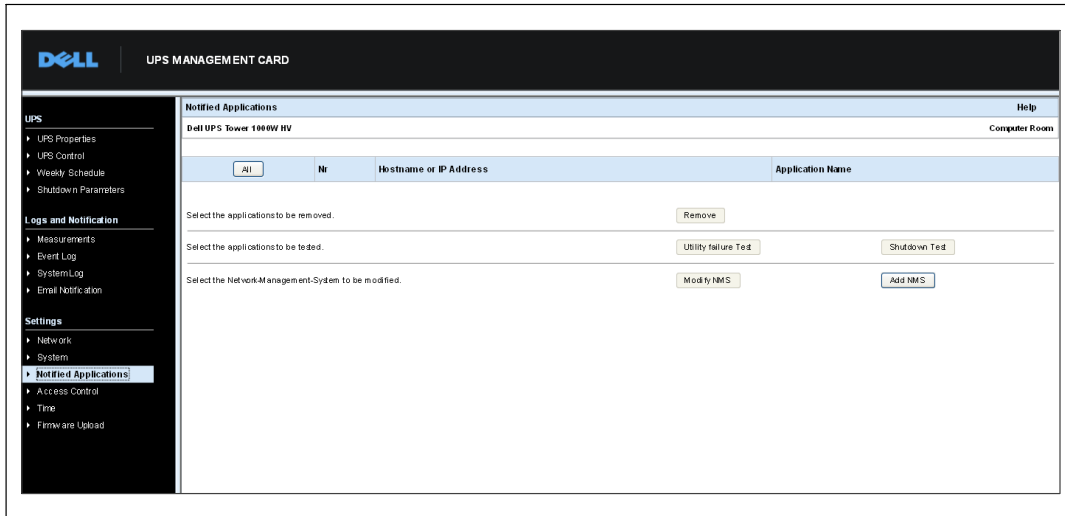

Figure 33. Notified Applications Page

- Click either **Modify NMS** or **Add NMS** to open a new window where you can modify or enter SNMP trap receiver information (Application Name, Hostname or IP Address, Trap Community, and Severity). See Figure 34.

The screenshot displays the 'Add NMS' configuration page within the Dell UPS Management Card interface. The page is titled 'UPS MANAGEMENT CARD' and 'Network Management System'. The main content area shows a form for adding a new NMS entry. The form includes fields for 'Application Name', 'Hostname or IP Address', 'Protocol' (set to 'SNMP V1'), 'Trap Community', and 'Severity' (set to '1 - Warning'). There are 'Cancel' and 'Save' buttons at the bottom of the form. A sidebar on the left contains navigation options under 'UPS', 'Logs and Notification', and 'Settings'.

Network Management System	
Dell UPS Tower 1600W HV	Computer Room
Application Name :	<input type="text"/>
Hostname or IP Address :	<input type="text"/>
Protocol :	SNMP V1
Trap Community :	<input type="text"/>
Severity :	1 - Warning
<input type="button" value="Cancel"/> <input type="button" value="Save"/>	

Figure 34. Add NMS Page

Access Control

Click **Access Control** from the menu bar to configure the different parameters to allow secure access to the card using a browser or SNMP.



NOTE: If you are not already logged on, you will be prompted to enter your user name and password before accessing this page.



NOTE: Restart the card to activate any configuration changes.

The screenshot displays the 'Access Control' configuration page for a Dell UPS Management Card. The page has a dark header with the Dell logo and 'UPS MANAGEMENT CARD'. A left sidebar contains a navigation menu with categories: UPS (UPS Properties, UPS Control, Weekly Schedule, Shutdown Parameters), Logs and Notification (Measurements, Event Log, System Log, Email Notification), and Settings (Network, System, Notified Applications, Access Control, Time, Firmware Upload). The 'Access Control' page content includes: 'Dell UPS Tower 1000W HV' and 'Computer Room' (with a 'Help' link); 'Enter New Manager Login:' with a text field containing 'admin'; 'Enter New Password:' and 'Confirm New Password:' with masked text fields; 'SNMP:' with a dropdown menu set to 'Disabled'; 'Current Community Read-Only is:' with a text field containing 'public'; 'Change Community Read-Only:' with a text field containing 'public'; 'Security mode:' with three radio buttons: 'Authentication for configuration' (selected), 'Full authentication', and 'SSL and full authentication'; and a 'Save' button under 'Save modified settings:'.

Figure 35. Access Control Page

Configurable access control settings are:

- **Enter New Manager User Name:** This text field (limited to ten characters) enables secure access and modification of pages. Default value is **admin**.
- **Enter New Password:** This text field (limited to ten characters) enables secure access to Configuration menu pages. Default value is **admin**.
- **Confirm New Password:** Re-enter the new password.
- **SNMP:** This option allows enabling or disabling SNMP communication. Default value is **Disabled**.
- **Current Community Read-Only name is:** Displays the current the SNMP community name used for read operations.
- **Change Community Read-Only:** This text field (limited to 49 characters) enables the SNMP community name used for read operations to be changed.

- **Security mode:** Manages the various authentication methods for page access. The default method is **SSL and full authentication**. Security modes options are:
 - **Authentication for configuration:** Only the configuration pages are protected by user name and password.
 - **Full authentication:** All pages are protected by a user name and password.
 - **SSL and full authentication:** All pages are protected by user name and password and are accessible only in SSL.

When **SSL and full authentication** is selected, access to the Web interface is made in secure mode (https). Connections with Network Shutdown Modules stay in standard mode (secure TCP).

SSL Security Implementation:

- SSL Version 3.0
 - TLS Version 1.0
 - Method: TLS_RSA_WITH_512_MD5
 - Auth: RSA
 - Key Exchange: RSA
 - Encryption: RCA_512
 - Digest: MD5
- **Save:** Saves any modifications.

Date and Time

You can set the card's date and time manually or set to synchronize with the NTP server from the Setting time page (see Figure 36).

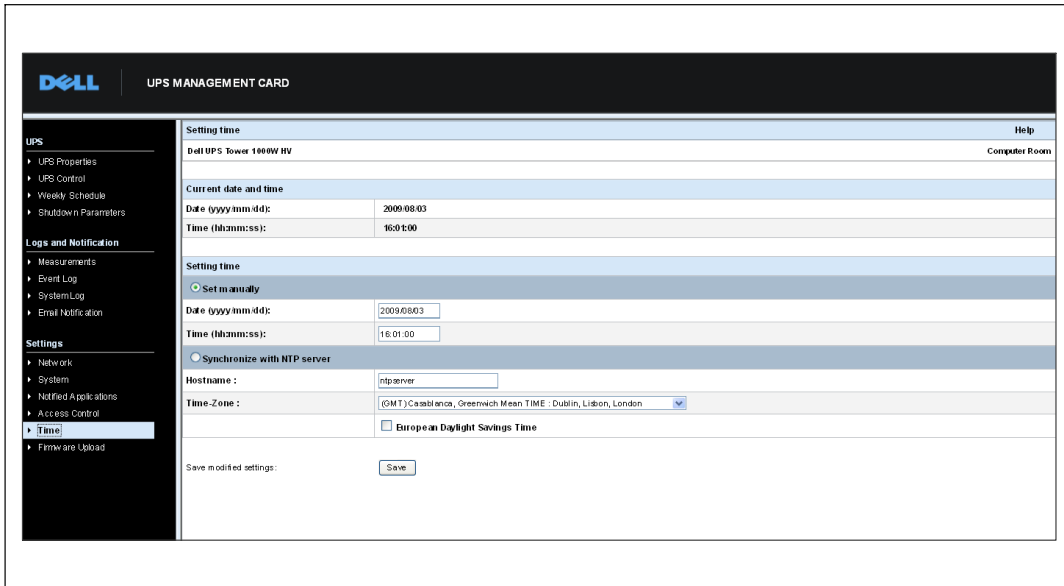

Figure 36. Setting Time Page

To set the date and time:

- 1** Click **Time** from the menu bar to open the Setting time page.
- 2** To manually set the date and time, select **Set manually** and enter values in the **Date** and **Time** fields, and click **Save**. Maximum drift is ± 2 min/month.
- 3** To synchronize the time with the NTP server, select **Synchronize with NTP server**. Selecting this option enables a connection with a time server, available either on the company's internal network or on the Web. This server communicates GMT time.
 - Enter the IP address or host name of the time server.
 - Select the time zone for your geographic area from the list.
 - Click **Save** to connect with the server and set the date and time.

The time is updated every five hours to prevent any time drift. After two attempts, if the NTP server is not accessible, the card shifts to manual mode. The card uses the NTP protocol (UDP 123 port). The firewall must be set to transmit queries outside the intranet. No error message is generated if the time server contact fails.



NOTE: After startup, if the card is in manual mode, or if no NTP server was reached, the card initializes at 00:00 01/01/1970.



NOTE: If the card is installed in a UPS that supports time-stamping, the card's time is automatically synchronized with that of the UPS.

MIB Objects

This chapter describes the Management Information Base (MIB) files available with the card. A MIB is an information repository residing on a device in a communication network. Network management software uses a device's MIB to manage the device. Every manageable device on a network has a MIB consisting of one or more files that list information about the device.

Use the facilities provided by your Simple Network Management Protocol (SNMP) management software to access the individual MIB objects. The objects define the information available about your UPS.

You can configure a device so that it generates a trap if a certain condition occurs, such as an alarm clearing. The trap is sent to the management station to inform it of the occurrence.

This chapter contains an overview of MIB definitions for each of the MIB files:

- IETF UPS MIB
- Dell UPS MIB
- RFC 1213 UPS MIB II

IETF UPS MIB

Table 11 lists IETF UPS MIB objects. The MIB OID (object identifier) is 1.3.6.1.2.33. All variables are in read-only mode.

Table 11. IETF UPS MIB Objects

Variable Name and Relative XML Object Path	OID	Variable Type	Variable Unit
upsIdentManufacturer UPS.PowerSummary.iManufacturer	1.1.1	Display String	—
upsIdentModel UPS.PowerSummary.iModel	1.1.2	Display String	—
upsIdentUPSSoftwareVersion UPS.PowerSummary.iVersion	1.1.3	Display String	—
upsIdentAgentSoftwareVersion No Relative XML Object Path	1.1.4	Display String	—
upsBatteryStatus UPS.PowerSummary.PresentStatus.BelowRemainingCapacityLimit	1.2.1	Integer	—
upsSecondsOnBattery UPS.PowerSummary.PresentStatus.Discharging	1.2.2	Integer	Sec

Table 11. IETF UPS MIB Objects (continued)

Variable Name and Relative XML Object Path	OID	Variable Type	Variable Unit
upsEstimatedMinutesRemaining UPS.PowerSummary.RunTimeToEmpty	1.2.3	Integer	Min
upsEstimatedChargeRemaining UPS.PowerSummary.RemainingCapacity	1.2.4	Integer	%
upsBatteryVoltage UPS.PowerSummary.Voltage	1.2.5	Integer	0.1V
upsBatteryCurrent UPS.PowerSummary.Current	1.2.6	Integer	0.1A
upsBatteryTemperature UPS.BatterySystem.Battery.Temperature	1.2.7	Integer	°C
upsInputLineBads No Relative XML Object Path	1.3.1	Counter	—
upsInputNumLines No Relative XML Object Path	1.3.2	Integer	—
upsInputFrequency UPS.PowerConverter.Input[1].Frequency	1.3.3.1.2	Integer	0.1 Hz
upsInputVoltage UPS.PowerConverter.Input[1].Voltage	1.3.3.1.3	Integer	V
upsInputCurrent UPS.PowerConverter.Input[1].Current	1.3.3.1.4	Integer	0.1 A
upsOutputSource No Relative XML Object Path	1.4.1	Integer	—
upsOutputFrequency UPS.PowerConverter.Output.Frequency	1.4.2	Integer	0.1 Hz
upsOuputNumLines No Relative XML Object Path	1.4.3	Integer	—
upsOutputVoltage UPS.PowerConverter.Output.Voltage	1.4.4.1.2	Integer	V
upsOutputCurrent UPS.PowerConverter.Output.Current	1.4.4.1.3	Integer	0.1A
upsOutputPower UPS.PowerConverter.Output.ActivePower	1.4.4.1.4	Integer	W
upsOutputPercentLoad UPS.PowerSummary.PercentLoad	1.4.4.1.5	Integer	%

Table 11. IETF UPS MIB Objects (continued)

Variable Name and Relative XML Object Path	OID	Variable Type	Variable Unit
upsBypassNumLines No Relative XML Object Path	1.5.2	Integer	—
upsBypassVoltage UPS.PowerConverter.Input[2].Voltage	1.5.3.1.2	Integer	V
upsBypassCurrent UPS.PowerConverter.Input[2].Current	1.5.3.1.3	Integer	0.1A
upsBypassPower No Relative XML Object Path	1.5.3.1.4	Integer	W
upsAlarmsPresent No Relative XML Object Path	1.6.1	Gauge	—
upsAlarmTable No Relative XML Object Path	—	—	—
upsAlarmBatteryBad UPS.PowerSummary.PresentStatus.NeedReplacement	1.6.3.1	—	—
upsAlarmOnBattery UPS.PowerSummary.PresentStatus.Discharging	1.6.3.2	—	—
upsAlarmLowBattery UPS.PowerSummary.PresentStatus.BelowRemainingCapacityLimit	1.6.3.3	—	—
upsAlarmDepletedBattery Relative XML Object Path not implemented	1.6.3.4	—	—
upsAlarmTempBad UPS.PowerSummary.PresentStatus.OverTemperature	1.6.3.5	—	—
upsAlarmInputBad UPS.PowerConverter.Input[1].PresentStatus.VoltageOutOfRange	1.6.3.6	—	—
upsAlarmOutputBad Relative XML Object Path not implemented	1.6.3.7	—	—
upsAlarmOutputOverload UPS.PowerSummary.PresentStatus.Overload	1.6.3.8	—	—
upsAlarmOnBypass UPS.PowerConverter.Input[2].PresentStatus.Used	1.6.3.9	—	—
upsAlarmBypassBad UPS.PowerConverter.Input[2].PresentStatus.Good	1.6.3.10	—	—
upsAlarmOutputOffAsRequested Relative XML Object Path not implemented	1.6.3.11	—	—

Table 11. IETF UPS MIB Objects (continued)

Variable Name and Relative XML Object Path	OID	Variable Type	Variable Unit
upsAlarmUpsOffAsRequested Relative XML Object Path not implemented	1.6.3.12	—	—
upsAlarmChargerFailed UPS.BatterySystem.Charger.PresentStatus.InternalFailure	1.6.3.13	—	—
upsAlarmUpsOutputOff UPS.PowerSummary.PresentStatus.Good	1.6.3.14	—	—
upsAlarmUpsSystemOff Relative XML Object Path not implemented	1.6.3.15	—	—
upsAlarmFanFailure UPS.PowerSummary.PresentStatus.FanFailure	1.6.3.16	—	—
upsAlarmFuseFailure UPS.BatterySystem.Battery.PresentStatus.FuseFault UPS.PowerConverter.Input[1].PresentStatus.FuseFault UPS.PowerConverter.Inverter.PresentStatus.FuseFault	1.6.3.17	—	—
upsAlarmGeneralFault UPS.PowerSummary.PresentStatus.InternalFailure	1.6.3.18	—	—
upsAlarmDiagnosticTestFailed Relative XML Object Path not implemented	1.6.3.19	—	—
upsAlarmCommunicationsLost UPS.PowerSummary.PresentStatus.CommunicationLost	1.6.3.20	—	—
upsAlarmAwaitingPower Relative XML Object Path not implemented	1.6.3.21	—	—
upsAlarmShutdownPending UPS.PowerSummary.DelayBeforeShutdown	1.6.3.22	—	—
upsAlarmShutdownImminent UPS.PowerSummary.PresentStatus.ShutdownImminent	1.6.3.23	—	—
upsTestResultsSummary UPS.BatterySystem.Battery.Test	1.7.3	Integer	{1,2,3,4,5,6}
upsShutdownType No Relative XML Object Path	1.8.1	Integer	Sec
upsShutdownAfterDelay UPS.PowerSummary.DelayBeforeShutdown	1.8.2	Integer	Sec
upsStartupAfterDelay UPS.PowerSummary.DelayBeforeStartup	1.8.3	Integer	Sec

Table 11. IETF UPS MIB Objects (continued)

Variable Name and Relative XML Object Path	OID	Variable Type	Variable Unit
upsConfigInputVoltage UPS.Flow[1].ConfigVoltage	1.9.1	Integer	V
upsConfigInputFreq UPS.Flow[1].ConfigFrequency	1.9.2	Integer	0.1 Hz
upsConfigOutputVoltage UPS.Flow[4].ConfigVoltage	1.9.3	Integer	V
upsConfigOutputFreq UPS.Flow[4].ConfigFrequency	1.9.4	Integer	0.1 Hz
upsConfigOutputVA UPS.Flow[4].ConfigApparentPower	1.9.5	Integer	VA
upsConfigOutputPower UPS.Flow[4].ConfigActivePower	1.9.6	Integer	W
upsConfigLowBattTime No Relative XML Object Path	1.9.7	Integer	Min
upsConfigAudibleStatus UPS.BatterySystem.Battery.AudibleAlarmControl	1.9.8	Integer	—
upsConfigLowVoltageTransferPoint UPS.PowerConverter.Output.LowVoltageTransfer	1.9.9	Integer	V
upsConfigHighVoltageTransferPoint UPS.PowerConverter.Output.HighVoltageTransfer	1.9.10	Integer	V

Dell UPS MIB

 **NOTE:** Not every UPS model implements all of the Dell UPS MIB objects. For example, the bypass objects are supported only by larger UPSs with a separate bypass feed.

The Dell OID is 674. The Dell UPS MIB must start at OID at 1.3.6.1.4.1.674.10902.2.

The Dell UPS MIB consists of the following groups:

- Product identification
- Product status
- Product physical

Product Identification Group

The name of the group is “ProductID” with a group OID of 100. See Table 12 for OID 100 group variables.

Table 12. Product Identification Variables

Variable Name and Description	OID	Variable Type
productIDDisplayName Name of this product for display purposes.	1	Display String
productIDDescription A short description of this product, such as: “Software for the management of clusters.”	2	Display String
productIDVendor The name of the product manufacturer.	3	Display String
productIDVersion The version of this product.	4	Display String
productIDBuildNumber The software build number of the product populating the MIB.	5	Display String
productIDURL The URL of the Web-based application to manage this device, should the device provide one.	6	Display String
productIDDeviceNetworkName Operating system specific computer name if product SNMP service is hosted.	7	Display String

Product Status Group

The name of the group is “ProductStatus” with a group OID of 110. See Table 13 for OID 110 group variables.

Table 13. Product Status Group Variables

Variable Name and Description	OID	Variable Type
productStatusGlobalStatus Current status of the product. This is a roll-up for the entire product including any monitored devices. The status is intended to give initiative to an SNMP monitor to get further data when this status is abnormal. This variable can take the following values: <ul style="list-style-type: none">• Other• Unknown• OK• Non-critical• Critical• Non-recoverable	1	Integer
productStatusLastGlobalStatus The status before the current status which induced an initiative to issue a global status change trap.	2	Integer
productStatusTimeStamp The last time that the SNMP table geometries changed and/or attribute data were significantly updated. This is used by management applications to trigger a refresh of data acquired from the MIB. This time should be a relative timestamp, for example the value of MIB II SysUpTime when the values are updated or some other equivalent.	3	Integer
productStatusGetTimeOut Suggested time out value in milliseconds for how long the SNMP getter should wait while attempting to poll the product SNMP service.	4	Integer
productStatusRefreshRate Rate in seconds at which the SNMP service cached data is being updated.	5	Integer
productStatusGeneratingTrapFlag Indicates if this SNMP sub-agent is capable of and/or is generating SNMP traps. This variable can take the following values: <ul style="list-style-type: none">• True—this service is capable of sending traps and is the originator of SNMP traps generated for the devices represented in this MIB and is currently generating traps.• False—this service is not capable of sending traps and is not the originator of any SNMP traps generated for the devices represented in this MIB.• Disabled—this service is capable of sending traps and is the originator of SNMP traps for the devices represented in this MIB, but traps are currently disabled.	6	Integer

Product Physical Group

The name of the group is “Physical” with a group OID of 120. See Table 14 for OID 120 group variables.

Table 14. Product Physical Group Variables

Variable Name and Description	OID	Variable Type	Variable Unit
physicalIdentFamilyName UPS Family name UPS.PowerSummary.iProduct	1.1	String	—
physicalIdentSerialNumber UPS Serial number UPS.PowerSummary.iSerialNumber	1.2	String	—
physicalIdentConverterType UPS type:Off Line / Line interactiveOn LineOn Line - Unitary/ParallelOn Line - Parallel with NSOn Line - Hot Standby Redundancy (set on redundant UPS) UPS.PowerConverter.ConverterType	1.3	Integer	—
physicalOutputInstantHeadroom This is the present amount of watt capacity remaining before overload. (Present Watts – Watts Rating of UPS = Headroom Watts) UPS.PowerConverter.Output.RemainingActivePower	2.1	Integer	Watts
physicalOutputPeakHeadroom Statistical value holding the lowest value that Instantaneous Headroom Watts was ever set to since the last time this statistic was reset UPS.StatisticSystem.Output.Statistic[2].RemainingActivePower	2.2	Integer	Watts
physicalOutputPeakHeadroomTimestamp Time and date stamp of the last time the Peak Headroom Watts value was updated UPS.StatisticSystem.Output.Statistic[2].Time	2.3	Integer	Time Stamp
physicalOutputPeakConsumption Statistical value of the maximum RMS Watts the UPS has seen since the last time this statistic was reset UPS.StatisticSystem.Output.Statistic[3].ActivePower	2.4	Integer	Watts
physicalOutputPeakConsumptionTimestamp Time and date stamp of the last time the Peak Consumption Watts value was updated UPS.StatisticSystem.Output.Statistic[2].Time	2.5	Integer	Time Stamp

Table 14. Product Physical Group Variables (continued)

Variable Name and Description	OID	Variable Type	Variable Unit
physicalOutputPresentConsumption Derived by averaging the watt second consumption over the past hour. Use an array of 60 words to store the average watt seconds consumed over the last minute; then, after you have a full hour's worth of data in the 60 word array, average those values to get your Present kWh Consumption meter. Each minute thereafter, update the oldest value in the array, average again, and update the meter. Value is 0 until the minimum 1 hour of data have been accumulated. UPS.StatisticSystem.Output.Statistic[1].Energy / UPS.StatisticSystem.Output.Statistic[4].Interval	2.6	Integer	kWh
physicalOutputCumulativeConsumption 64 bit meter value that is derived by reading the Present kWh Consumption meter once per hour and adding it to the last value of this meter. Value accumulates until it is reset from the LCD or via the SHUT protocol or the meter rolls over. UPS.StatisticSystem.Output.Statistic[4].Energy	2.7	Integer	kWh
physicalOutputCumulativeConsumptionTimestamp Time and date stamp of last time this meter value was reset. UPS.StatisticSystem.Output.Statistic[4].Time	2.8	Integer	Time Stamp
physicalOutputVA Output VA UPS.PowerConverter.Output.ApparentPower	2.9	Integer	VA
physicalRectifierPosVoltage DC bus positive voltage (double-conversion models only) UPS.PowerConverter.Rectifier.Phase[1].Voltage	3.1	Integer	Volts
physicalRectifierNegVoltage DC bus negative voltage (double-conversion models only) UPS.PowerConverter.Rectifier.Phase[2].Voltage	3.2	Integer	Volts
physicalUPSDateTime Real-time clock with date and time UPS.PowerSummary.Time	4.1	Integer	Time Stamp
physicalUPSAlarmsStatus List of traps that are in active mode. This list is coded in ASCII format and each trap number is separated by a comma (example: 1,5,23,77). No XML Path	4.2	String	—

Table 14. Product Physical Group Variables (continued)

Variable Name and Description	OID	Variable Type	Variable Unit
physicalBatteryABMStatus Advanced Battery Monitoring status: 1: ABM charging 2: ABM discharging 3: ABM floating 4: ABM resting 5: ABM off UPS.BatterySystem.Charger.Mode	5.1	Integer	—
physicalBatteryTestStatus Battery test status: <ul style="list-style-type: none"> • Done and Passed • Done and Warning • Done and Error • Aborted • In progress • Not implemented • Scheduled UPS.BatterySystem.Battery.Test	5.2	Integer	—
physicalBatterySecondsRemaining Battery remaining time calculated by the autometer. UPS.PowerSummary.RunTimeToEmpty	5.3	Integer	Seconds
physicalLoadSegment1ShutdownAfterDelay Number of seconds remaining until load segment 1 switches off. -1 if no shutdown countdown is in effect. UPS.OutletSystem.Outlet[2].DelayBeforeShutdown	6.1	Integer	Seconds
physicalLoadSegment1StartupAfterDelay Number of seconds remaining until load segment 1 switches on. -1 if no startup countdown is in effect. UPS.OutletSystem.Outlet[2].DelayBeforeStartup	6.2	Integer	Seconds

Table 14. Product Physical Group Variables (continued)

Variable Name and Description	OID	Variable Type	Variable Unit
physicalLoadSegment2ShutdownAfterDelay Number of seconds remaining until Load Segment 2 switches off. -1 if no shutdown countdown is in effect. UPS.OutletSystem.Outlet[3].DelayBeforeShutdown	6.3	Integer	Seconds
physicalLoadSegment2StartupAfterDelay Number of seconds remaining until Load Segment 2 switches on. -1 if no startup countdown is in effect. UPS.OutletSystem.Outlet[3].DelayBeforeStartup	6.4	Integer	Seconds

Traps

Traps are sent on status transition (when an alarm appears or disappears). Traps are composed of three levels and can be filtered:

- Informational
- Warning
- Critical

Trap OID is: 1.3.6.1.4.1.674.10902.2.140 (see Table 15).

Table 15. Product Physical Group Variables

Trap Name, Description, and Relative XML Object Path	Trap	Trap Level
trapInverterOverVoltage Inverter AC over voltage (applies only to double-conversion models) UPS.PowerConverter.Inverter.PresentStatus.VoltageTooHigh = 1	1	2
trapInverterOverVoltageOk Inverter AC over voltage ok UPS.PowerConverter.Inverter.PresentStatus.VoltageTooHigh = 0	2	1
trapInverterUnderVoltage Inverter AC under voltage (applies only to double-conversion models) UPS.PowerConverter.Inverter.PresentStatus.VoltageTooLow = 1	3	2
trapInverterUnderVoltageOk Inverter AC under voltage ok UPS.PowerConverter.Inverter.PresentStatus.VoltageTooLow = 0	4	1

Table 15. Product Physical Group Variables (continued)

Trap Name, Description, and Relative XML Object Path	Trap	Trap Level
trapBypassFrequencyOutOfRange Bypass under or over frequency UPS.PowerConverter.Input[2].PresentStatus.FrequencyOutOfRange = 1	5	2
trapBypassFrequencyOutOfRangeOk Bypass under or over frequency ok UPS.PowerConverter.Input[2].PresentStatus.FrequencyOutOfRange = 0	6	1
trapOnBuck On Buck / Input Voltage Reducer UPS.PowerConverter.Input[1].PresentStatus.Buck = 1	7	1
trapReturnFromBuck Return from Buck UPS.PowerConverter.Input[1].PresentStatus.Buck = 0	8	1
trapOnBoost On Boost / Input Voltage Booster UPS.PowerConverter.Input[1].PresentStatus.Boost = 1	9	1
trapReturnFromBoost Return from Boost UPS.PowerConverter.Input[1].PresentStatus.Boost = 0	10	1
trapInputOverVoltage Input AC over voltage UPS.PowerConverter.Input[1].PresentStatus.VoltageTooHigh = 1	11	2
trapInputOverVoltageOk Input AC over voltage ok UPS.PowerConverter.Input[1].PresentStatus.VoltageTooHigh = 0	12	1
trapInputUnderVoltage Input AC under voltage UPS.PowerConverter.Input[1].PresentStatus.VoltageTooLow = 1	13	2
trapInputUnderVoltageOk Input AC under voltage ok UPS.PowerConverter.Input[1].PresentStatus.VoltageTooLow = 0	14	1
trapInputFrequencyOutOfRange Input under or over frequency UPS.PowerConverter.Input[1].PresentStatus.FrequencyOutOfRange = 1	15	2

Table 15. Product Physical Group Variables (continued)

Trap Name, Description, and Relative XML Object Path	Trap	Trap Level
trapInputFrequencyOutOfRangeOk Input under or over frequency ok UPS.PowerConverter.Input[1].PresentStatus.FrequencyOutOfRange = 0	16	1
trapRemoteEmergencyPowerOff Remote emergency power off UPS.PowerSummary.PresentStatus.EmergencyStop = 1	17	2
trapReturnFromEmergencyPowerOff Return from remote emergency power off UPS.PowerSummary.PresentStatus.EmergencyStop = 0	18	1
trapOutputOverload Output overload UPS.PowerSummary.PresentStatus.Overload = 1	19	2
trapOutputOverloadOk Output overload ok UPS.PowerSummary.PresentStatus.Overload = 0	20	1
trapLevel2Overload Level 2 overload UPS.PowerConverter.Output.Overload[1].PresentStatus.OverThreshold = 1	21	2
trapLevel2OverloadOk Level 2 overload ok UPS.PowerConverter.Output.Overload[1].PresentStatus.OverThreshold = 0	22	1
trapLevel3Overload Level 3 overload UPS.PowerConverter.Output.Overload[2].PresentStatus.OverThreshold = 1	23	3
trapLevel3OverloadOk Level 3 overload ok UPS.PowerConverter.Output.Overload[2].PresentStatus.OverThreshold = 0	24	1
trapPosDCLinkOverVoltage Positive DC link over voltage (applies only to double-conversion models) UPS.PowerConverter.Rectifier.PresentStatus.HighPositiveDCBusVoltage = 1	25	2
trapPosDCLinkOverVoltageOk Positive DC link over voltage ok UPS.PowerConverter.Rectifier.PresentStatus.HighPositiveDCBusVoltage = 0	26	1

Table 15. Product Physical Group Variables (continued)

Trap Name, Description, and Relative XML Object Path	Trap	Trap Level
trapPosDCLinkUnderVoltage Positive DC link under voltage (applies only to double-conversion models) UPS.PowerConverter.Rectifier.PresentStatus.LowPositiveDCBusVoltage = 1	27	2
trapPosDCLinkUnderVoltageOk Positive DC link under voltage ok UPS.PowerConverter.Rectifier.PresentStatus.LowPositiveDCBusVoltage = 0	28	1
trapNegDCLinkOverVoltage Negative DC link over voltage (applies only to double-conversion models) UPS.PowerConverter.Rectifier.PresentStatus.HighNegativeDCBusVoltage = 1	29	2
trapNegDCLinkOverVoltageOk Negative DC link over voltage ok UPS.PowerConverter.Rectifier.PresentStatus.HighNegativeDCBusVoltage = 0	30	1
trapNegDCLinkUnderVoltage Negative DC link under voltage (applies only to double-conversion models) UPS.PowerConverter.Rectifier.PresentStatus.LowNegativeDCBusVoltage = 1	31	2
trapNegDCLinkUnderVoltageOk Negative DC link under voltage ok UPS.PowerConverter.Rectifier.PresentStatus.LowNegativeDCBusVoltage = 0	32	1
trapRectifierFault Rectifier fault (applies only to double-conversion models) UPS.PowerConverter.Rectifier.PresentStatus.InternalFailure = 1	33	3
trapRectifierOk Rectifier ok UPS.PowerConverter.Rectifier.PresentStatus.InternalFailure = 0	34	1
trapInverterFault Inverter fault (applies only to double-conversion models) UPS.PowerConverter.Inverter.PresentStatus.InternalFailure = 1	35	3
trapInverterOk Inverter ok UPS.PowerConverter.Inverter.PresentStatus.InternalFailure = 0	36	1
trapChargerFailure Charger failure UPS.BatterySystem.Charger.PresentStatus.InternalFailure = 1	37	3

Table 15. Product Physical Group Variables (continued)

Trap Name, Description, and Relative XML Object Path	Trap	Trap Level
trapChargerOk Charger ok UPS.BatterySystem.Charger.PresentStatus.InternalFailure = 0	38	1
trapEepromFailure EEPROM failure UPS.PowerSummary.PresentStatus.ConfigurationFailure = 1	39	3
trapEepromOk EEPROM ok UPS.PowerSummary.PresentStatus.ConfigurationFailure = 0	40	1
trapShutdownImminent Shutdown imminent UPS.PowerSummary.PresentStatus.ShutdownImminent = 1	41	3
trapShutdownImminentOver Shutdown imminent over UPS.PowerSummary.PresentStatus.ShutdownImminent = 0	42	1
trapBatteryLow Battery low UPS.PowerSummary.PresentStatus.BelowRemainingCapacityLimit = 1	43	3
trapBatteryOk Battery ok UPS.PowerSummary.PresentStatus.BelowRemainingCapacityLimit = 0	44	1
trapOutputShortCircuit Output short circuit UPS.PowerConverter.Output.PresentStatus.ShortCircuit = 1	45	3
trapOutputReturnFromShortCircuit Output return from short circuit UPS.PowerConverter.Output.PresentStatus.ShortCircuit = 0	46	1
trapUtilityNotPresent Utility not present UPS.PowerConverter.Input[1].PresentStatus.VoltageOutOfRange = 1	47	2
trapUtilityPresent Utility present UPS.PowerConverter.Input[1].PresentStatus.VoltageOutOfRange = 0	48	1

Table 15. Product Physical Group Variables (continued)

Trap Name, Description, and Relative XML Object Path	Trap	Trap Level
trapBatteryOverVoltage Battery DC over voltage UPS.BatterySystem.Battery.PresentStatus.VoltageTooHigh = 1	49	3
trapBatteryOverVoltageOk Battery DC over voltage ok UPS.BatterySystem.Battery.PresentStatus.VoltageTooHigh = 0	50	1
trapHeatsinkOvertemperature Heatsink overtemperature UPS.PowerSummary.PresentStatus.OverTemperature = 1	51	3
trapHeatsinkOvertemperatureOk Heatsink overtemperature ok UPS.PowerSummary.PresentStatus.OverTemperature = 0	52	1
trapBypassNotAvailable Bypass not available (applies only to double-conversion models) UPS.PowerConverter.Input[2].PresentStatus.Good = 0	53	2
trapBypassNotAvailableOk Bypass not available ok UPS.PowerConverter.Input[2].PresentStatus.Good = 1	54	1
trapUPSONBattery UPS on battery UPS.PowerConverter.Input[3].PresentStatus Used = 1	57	1
trapUPSReturnFromBattery UPS return from battery UPS.PowerConverter.Input[3].PresentStatus Used = 0	58	1
trapUPSONBypass UPS on bypass (applies only to double-conversion models) UPS.PowerConverter.Input[2].PresentStatus.Used = 1	59	1
trapUPSReturnFromBypass UPS return from bypass UPS.PowerConverter.Input[2].PresentStatus.Used = 0	60	1
trapBatteryTestInProgress Battery manual or automatic test in progress UPS.BatterySystem.Battery.Test = 5	61	1

Table 15. Product Physical Group Variables (continued)

Trap Name, Description, and Relative XML Object Path	Trap	Trap Level
trapBatteryTestDone (physical BatteryTestStatus) Battery test done Variable: physicalBatteryTestStatusUPS.BatterySystem.Battery.Test ? 5	62	1
trapBatteryNeedReplacement Battery test failed, battery needs to be replaced UPS.PowerSummary.PresentStatus.NeedReplacement = 1	63	3
trapBatteryReplacementDone Battery replacement done UPS.PowerSummary.PresentStatus.NeedReplacement = 0	64	1
trapFanFailure Fan failure UPS.PowerSummary.PresentStatus.FanFailure = 1	65	3
trapFanOk Fan ok UPS.PowerSummary.PresentStatus.FanFailure = 0	66	1
trapSiteWiringFault Site wiring fault UPS.PowerConverter.Input[1].PresentStatus.WiringFault = 1	67	3
trapSiteWiringOk Site wiring ok UPS.PowerConverter.Input[1].PresentStatus.WiringFault = 0	68	1
trapBatteryDisconnected Batteries disconnected UPS.BatterySystem.Battery.PresentStatus.Present = 0	69	3
trapBatteryConnected Batteries connected UPS.BatterySystem.Battery.PresentStatus.Present = 1	70	1
trapUPSOff UPS off UPS.PowerSummary.PresentStatus.Good = 0	71	2
trapUPSOn UPS on UPS.PowerSummary.PresentStatus.Good = 1	72	2

Table 15. Product Physical Group Variables (continued)

Trap Name, Description, and Relative XML Object Path	Trap	Trap Level
trapDCLinkImbalance DC link imbalance (applies only to double-conversion models) UPS.PowerConverter.Rectifier.PresentStatus.DCBusUnbalanced = 1	73	1
trapDCLinkImbalanceOk DC link imbalance ok UPS.PowerConverter.Rectifier.PresentStatus.DCBusUnbalanced = 0	74	1
trapABMOn (physicalBatteryABMStatus) ABM state on Variable: physicalBatteryABMStatusUPS.BatterySystem.Charger.Mode ? 5	79	2
trapABMOff ABM state off UPS.BatterySystem.Charger.PresentStatus.Used = 0	80	2
trapLoadSegment1Off Load segment 1 off UPS.BatterySystem.Charger.PresentStatus.Used = 0 AND UPS.BatterySystem.Charge.Mode = 5	81	2
trapLoadSegment1On Load segment 1 on UPS.OutletSystem.Outlet[2].PresentStatus.SwitchOnOff = 1	82	2
trapLoadSegment2Off Load segment 2 off UPS.OutletSystem.Outlet[3].PresentStatus.SwitchOnOff = 0	83	2
trapLoadSegment2On Load segment 2 on UPS.OutletSystem.Outlet[3].PresentStatus.SwitchOnOff = 1	84	2
trapInHighEfficiencyMode In High Efficiency mode UPS.PowerConverter.Input[5].PresentStatus.Used = 1	85	2
trapReturnFromHighEfficiencyMode Return from High Efficiency mode UPS.PowerConverter.Input[5].PresentStatus.Used = 0	86	1
trapRectifierOverload Rectifier input over current UPS.PowerConverter.Rectifier.PresentStatus.OverLoad = 1	87	2

Table 15. Product Physical Group Variables (continued)

Trap Name, Description, and Relative XML Object Path	Trap	Trap Level
trapRectifierOverloadOk Rectifier current ok UPS.PowerConverter.Rectifier.PresentStatus.OverLoad = 0	88	1
trapInverterOverload Inverter output over current UPS.PowerConverter.Inverter.PresentStatus.OverLoad = 1	89	2
trapInverterOverloadOk Inverter output current ok UPS.PowerConverter.Inverter.PresentStatus.OverLoad = 0	90	1
trapBypassVoltageOutOfRange Bypass AC under or over voltage UPS.PowerConverter.Input[2].PresentStatus.VoltageOutOfRange = 1	91	2
trapBypassVoltageOutOfRangeOk Bypass AC under or over voltage ok UPS.PowerConverter.Input[2].PresentStatus.VoltageOutOfRange = 0	92	1
trapServiceBattery Service battery UPS.BatterySystem.Charger.PresentStatus.Used = 0 AND UPS.BatterySystem.Charger.Mode = 4	93	2

Specifications

Table 16. Technical Specifications

Network Connection	10/100BaseT RJ-45 network connector
UPS Protocol	Dell UPS proprietary protocol
Network Protocols (not limited to)	DHCP DNS HTTP/HTTPS IPv4 and IPv6 NTP SMTP SNMP v1 (read only) TCP/IP
Supported SNMP MIBs	Dell UPS MIB IETF UPS MIB RFC 1213 MIB II
Operating Temperature	0° C to 40° C (32° F to 104° F)
Storage Temperature	-15° C to 60° C (5° F to 140° F)
Ambient Humidity	90% RH maximum without condensation
Power Consumption	1.5 watts maximum
Size (L x W x H)	132 mm × 66 mm × 42 mm (5.2" × 2.6" × 1.6")
Weight	70g (2.5 oz)
EMC Statements	Safety for ATI: IEC/EN 60950-1 2002 Safety for UPS: IEC/EN 62040-1-1 EMC: EN 61000-6-2 (2002), EN 61000-6-3 (2002), IEC/EN 62040-2 (2002)/C1/C2 For European directives: Low voltage: 2006/95/EC EMC: 2004/108/EC
RoHS	100% compatible

Operation and Maintenance

This chapter explains:

- Serial cable pinout
- Detailed serial configuration menus
- Firmware upgrade instructions

Serial Cable Pinout

Figure 37 shows the serial cable and pinout.

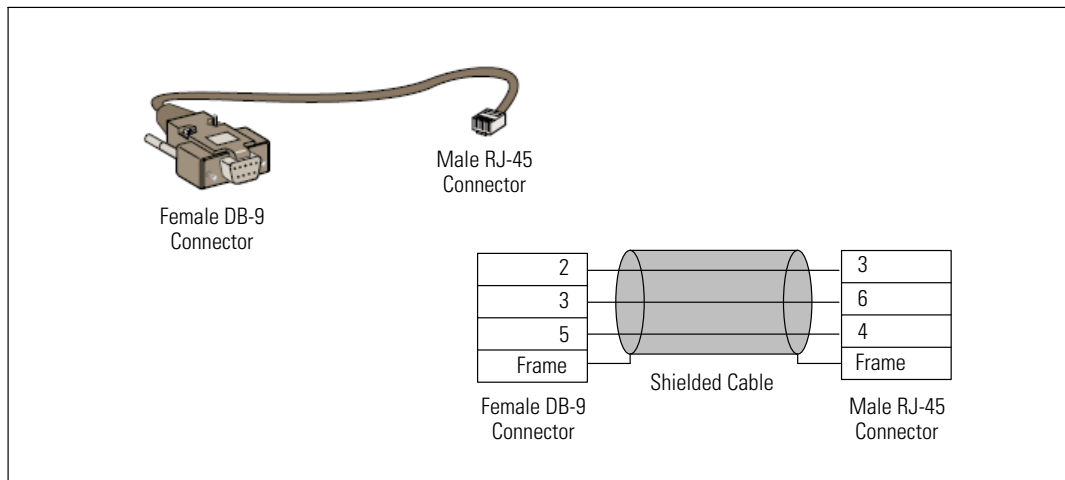

Figure 37. DB-9/RJ-45 Serial Cable and Pinout

Serial Configuration Menus

Use the supplied cable to connect the card to a computer.

- 1 Connect the card to a computer equipped with an emulator such as HyperTerminal. Set the serial link at **9600 baud, 8 bits, no parity, 1 stop bit, and no flow control**.
- 2 Verify that the UPS power is on.

- 3 Enter the **admin** password (not modifiable). The Dell Network Management Card main menu displays (see Figure 38).

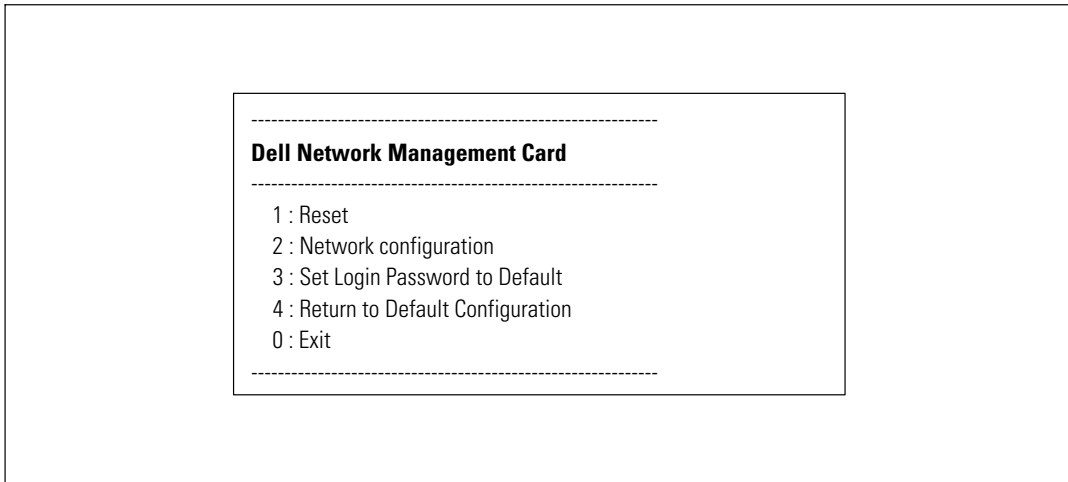

Figure 38. Dell Network Management Card Main Menu

Option 1: Reset

Two options are available for resetting the card (see Figure 39):

- **Hardware Reset:** Equivalent to a restart of the electrical power supply.
- **Restart application:** Restarts only the application.

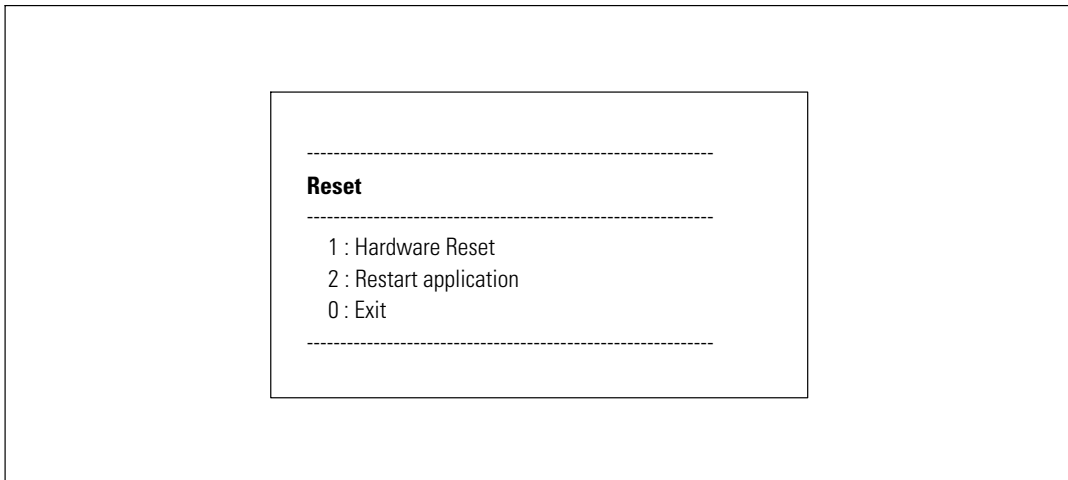

Figure 39. Reset Menu

Option 2: Network Configuration

The Network Configuration option displays additional options for network settings (see Figure 40):

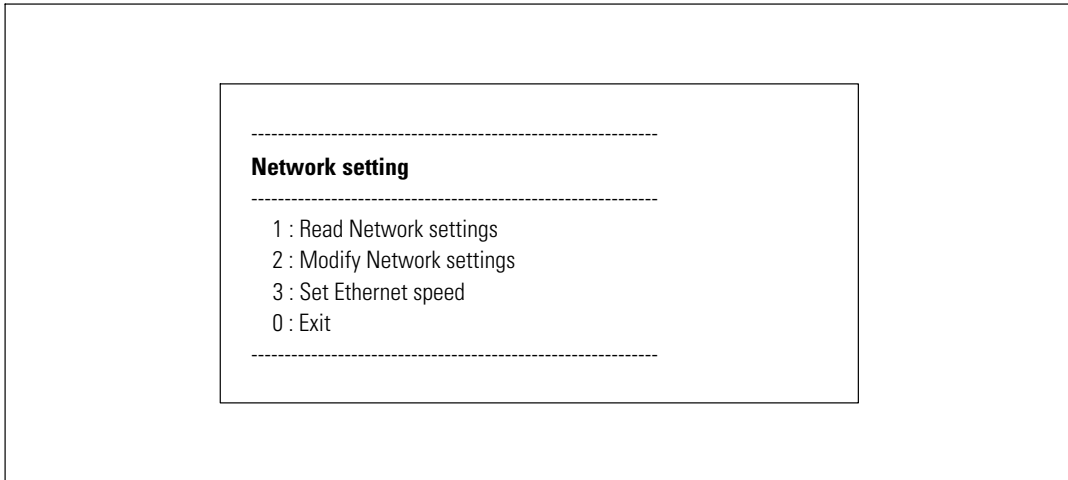

Figure 40. Network Settings Menu

Three options are available for the network settings:

- **Read Network settings:** To view the network settings (see Figure 41).

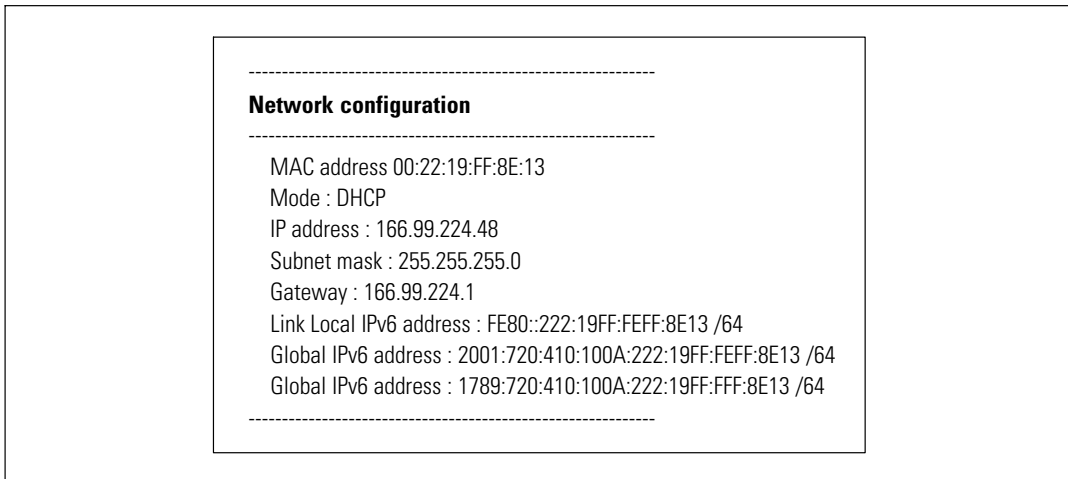

Figure 41. Read Network Settings Option

- **Modify Network settings:** To modify existing network parameters (see Figure 42). Restart the card to activate the new parameters. In DHCP mode, the card can receive the following parameters according to the DHCP server settings:
 - IP address
 - Subnet mask
 - Gateway address



NOTE: You cannot configure the IPv6 address through the serial link. The IPv6 address is provided by the card or by the IPv6 DHCP server (if an IPv6 DHCP server is available on the network). See “Network Settings” on page 49 to enable the IPv6 feature and configure IPv6 settings.

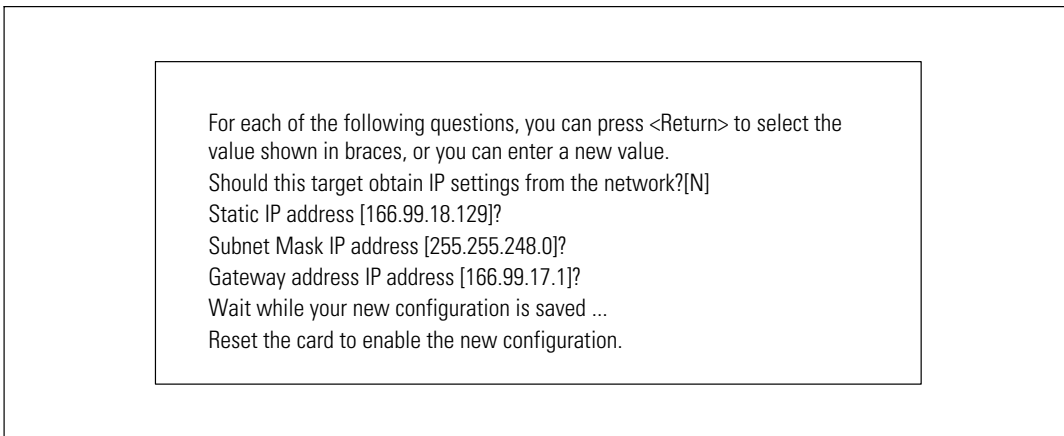

Figure 42. Modify Network Settings

- **Set Ethernet speed:** To change the network speed (see Figure 43). Restart the card to activate the new parameters.

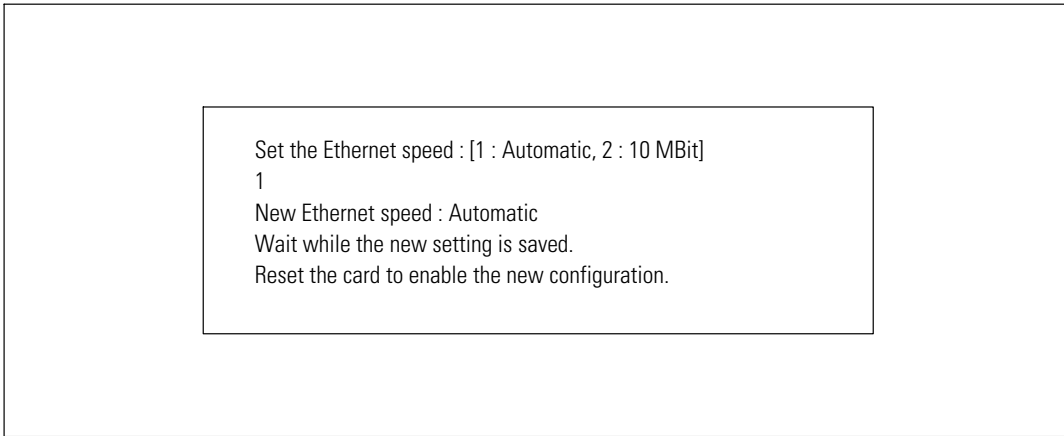

Figure 43. Ethernet Speed Settings

Option 3: Set Login Password to Default

Select menu item 3 to return the password to the default (**admin**). Wait for the confirmation message (see Figure 44). The card is now accessible using the Web with the default password admin, but you must restart the card to save the new password.

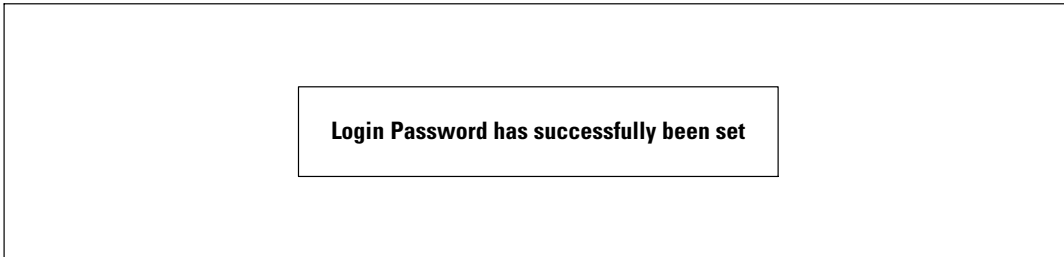

Figure 44. Default Password Confirmation Message

Option 4: Return to Default Configuration

Select menu item 4 to restore the parameters to the factory-default configuration (see “Card Defaults” on page 11). Wait for the confirmation message (see Figure 45). Restart the card to save the default parameters.

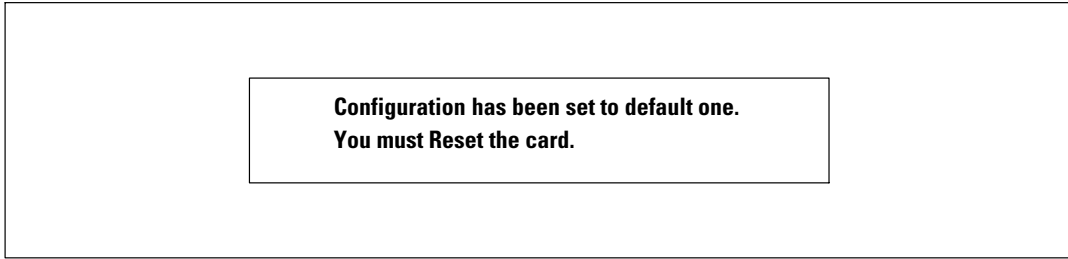



Figure 45. Default Configuration Confirmation Message

Upgrading the Card's Firmware

You can update the card's firmware by downloading the appropriate file. During the upgrade process, the Dell Network Management Card does not monitor the UPS status.

To upgrade the firmware:

- 1 Download the new firmware version to your computer from the Web and note the location.

 **NOTE:** Go to dell.support.com for more information on downloading firmware.

- 2 Click **Firmware Upload** from the menu bar to open the Firmware Upload page (see Figure 46).

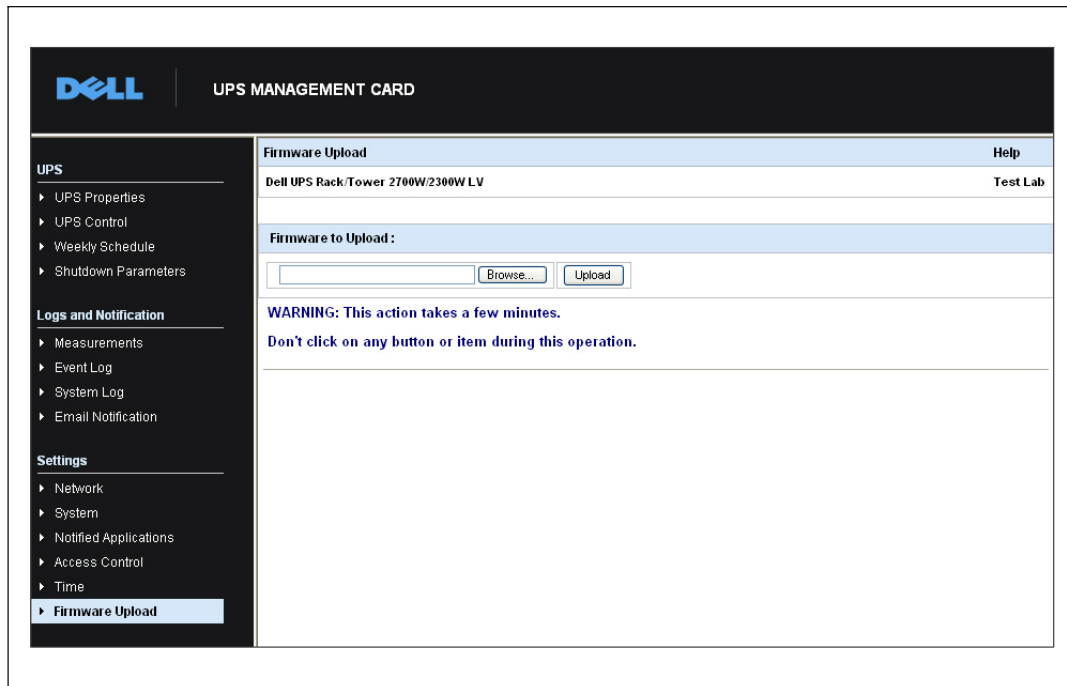

Figure 46. Firmware Upload Page

3 Click **Browse** to go to the firmware location and select the file to be loaded.

4 Click **Upload**.



NOTE: The upload can take up to five minutes. Do not interrupt the operation before the card displays confirmation that the firmware upload was successful (Figure 47).

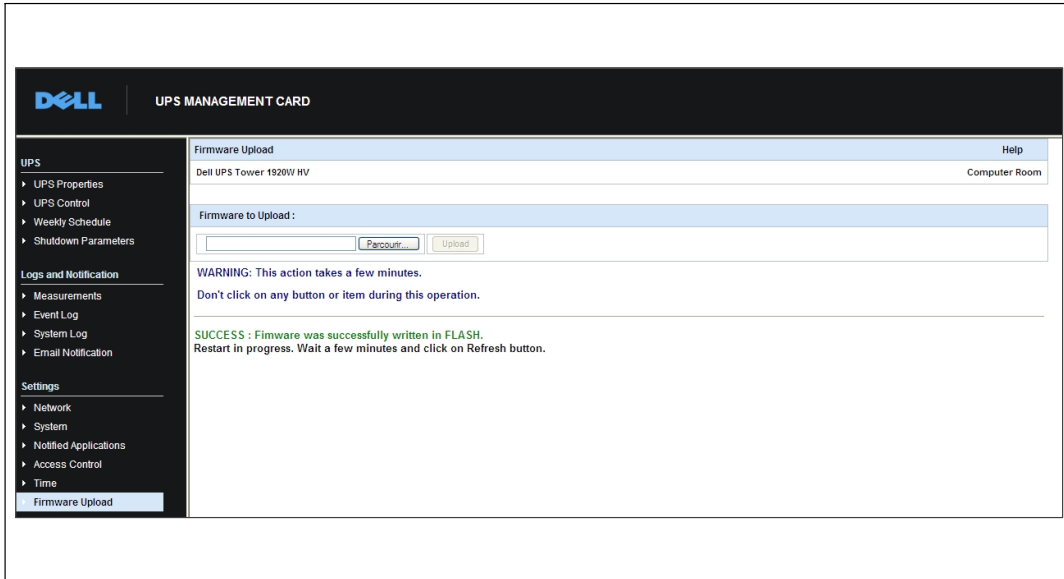

Figure 47. Firmware Upload Confirmation

Shutdown Criteria and Sequence

This chapter explains:

- Shutdown criteria managed by the card
- The shutdown sequence
- Load segments

Shutdown Criteria Managed by the Card

During an extended power failure, three criteria can cause the server shutdown procedure to be initiated. If multiple criteria are selected, the first criterion encountered launches the shutdown procedure. See Table 17 for criteria descriptions.



NOTE: See “Shutdown Parameters” on page 40 to view the shutdown parameters displayed on the Shutdown Parameters Web page.

Table 17. Shutdown Criteria

Criteria	Description
Backup Time before Initiating the Shutdown Procedure (Shutdown After – Shutdown Timer)	<p>When the UPS switches to battery power, the card starts the Shutdown Timer countdown and launches the system shutdown procedure at the end of the countdown. This value must be carefully selected so that users have time to complete their tasks and disconnect, without exceeding battery backup time.</p> <p>NOTE: If this criterion is selected to initiate system shutdown, automatic system reboot when power is restored is not guaranteed (for example, power restoration if only this system was shut down).</p>
Initiating the Shutdown Procedure when the Battery Level is Lower Than (If Capacity Under)	<p>When the card detects that the remaining backup time percentage is less than the configured level, the shutdown sequence is started. By default, this value is set at 20%.</p> <p>NOTE: The UPS already manages an equivalent parameter for the end of backup pre-alarm. The card does not accept values less than that programmed in the UPS. Check the UPS documentation.</p>
Shutdown When Backup Time is Less Than	<p>When the card detects that the percentage of backup time remaining is less than the set value, the shutdown sequence is started.</p>

Shutdown Sequence

At the end of the shutdown procedure, when all servers have been shut down, the UPS itself may shut down to avoid unnecessary discharge of its batteries, depending on its configuration. See Figure 48 for the shutdown sequence.

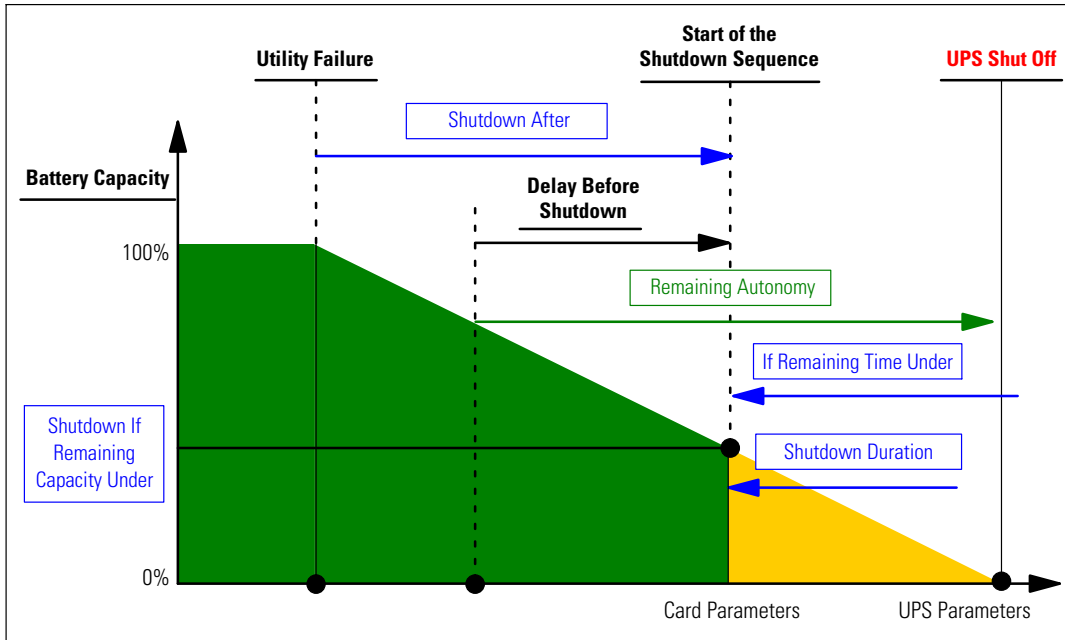

Figure 48. Shutdown Sequence

Load Segments

Some UPS models are equipped with load segments. Load segments are sets of receptacles that can be controlled through the Dell Network Management Card, providing an orderly shutdown and startup of your equipment. Load segments are dependent on the UPS's Inverter. Shutdown of the Inverter causes shutdown of the load segments (usually two load segments). Refer to the UPS user's guide for the location of the load segments.